

NOVACRONO

GIUGIARO
D E S I G N



mosaico+

NOVACRONO



NOVACRONO

GIUGIARO
DESIGN

mosaico+

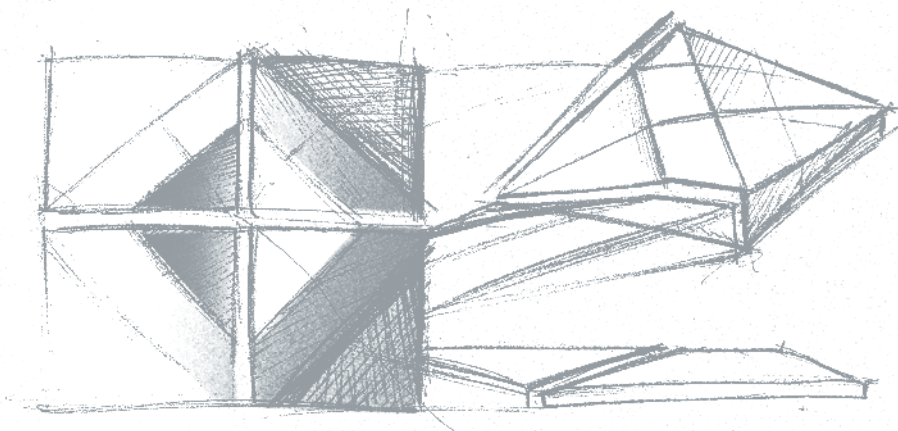

energia e piani prospettici, l'intuizione che sorprende
energy and perspective planes, intuition is surprising

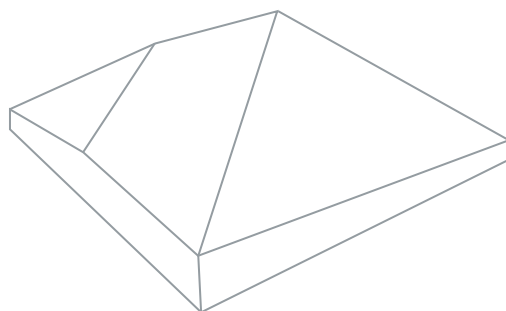

Una collezione ad alta tecnologia indissolubilmente intrecciata al design industriale: le tessere tridimensionali di Nova, realizzate in vetro sinterizzato ad altissima resistenza, compongono texture sofisticate dai mutevoli effetti, dati dalla rifrazione della luce sulle superfici variamente inclinate del mosaico. L'effetto dinamico che ne scaturisce si coniuga con il colore intenso e profondo, per composizioni dove i contrasti cromatici delle tessere e dei diversi layouts, ampliano l'orizzonte del rivestimento musivo, esprimendo con leggerezza ed armonia l'energia del vivere contemporaneo.

A high-tech collection, inextricably intertwined with industrial design: the three-dimensional Nova tiles, made using high strength sintered glass, compose sophisticated textures with changing effects, caused by the refraction of light over the differently inclined surfaces of the mosaic. The resulting dynamic effect combines with the intense, deep colour, for compositions where the colour contrasts of the tiles and the different layouts broaden the horizon of the mosaic coating, expressing the energy of contemporary living with lightness and harmony.

















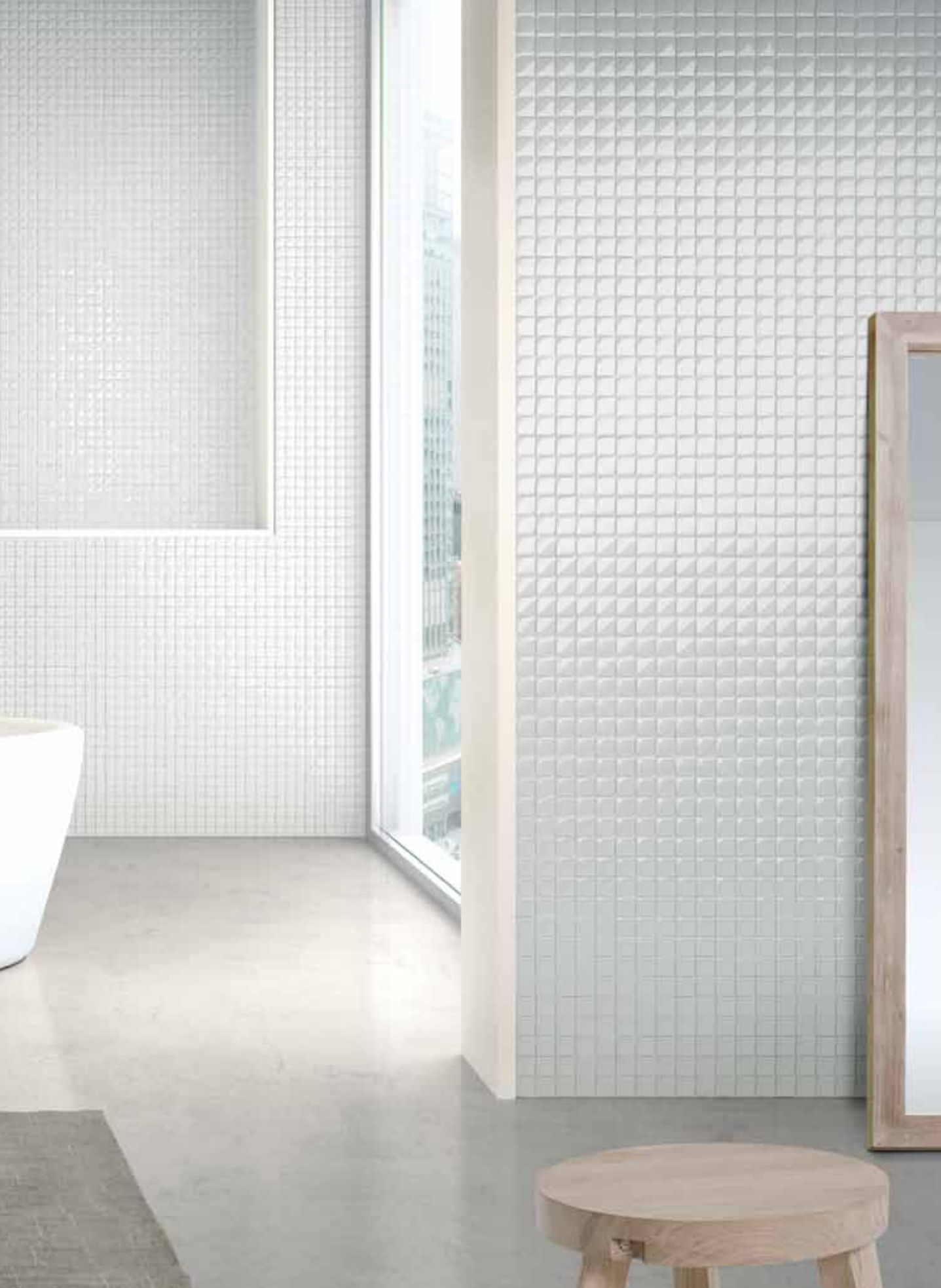

NOVACRONO

GIUGIARO
DESIGN

mosaico+



Bianco*



Grigio C.*



Grigio S.*



Nero*



Beige*



Verde Prato*



Petrolio*



Azzurro*



Blu*



Viola*



Rosso*

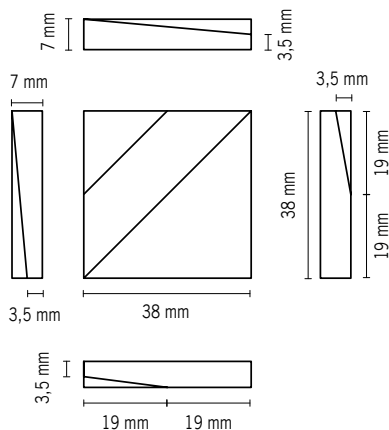

NOVA LAYOUT 1

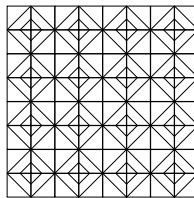

327x327 mm 12^{7/8}x12^{7/8}"

38x38 mm
1^{1/2}x1^{1/2}"

NOVA LAYOUT 2

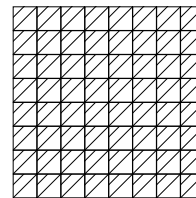

327x327 mm 12^{7/8}x12^{7/8}"

38x38 mm
1^{1/2}x1^{1/2}"

NOVA LAYOUT 3

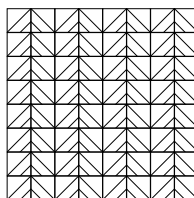

327x327 mm 12^{7/8}x12^{7/8}"

38x38 mm
1^{1/2}x1^{1/2}"

NOVA LAYOUT 4

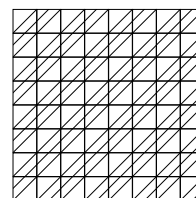

327x327 mm 12^{7/8}x12^{7/8}"

38x38 mm
1^{1/2}x1^{1/2}"

NOVA

Mosaico di vetro sinterizzato, riciclato al 95%, composto da tessere tridimensionali, non regolari, montate su pellicola trasparente (film). La forma tridimensionale della tessera prevede una posa senza stuccatura, fatta eccezione per il layout 1 e 4.

NOVA

Mosaic made from 95% recycled sintered glass, comprising irregular three-dimensional chips mounted on transparent film. Due to the three-dimensional chip shape, this material should be laid without grouting, except for layouts 1 and 4.

CARATTERISTICHE TECNICHE TECHNICAL CHARACTERISTICS

Assorbimento d'acqua Water absorption (UNI EN ISO 10545/3)	Resistenza al gelo Frost resistance (UNI EN ISO 10545/12)	Resistenza agli sbalzi termici Thermal shock resistance (UNI EN ISO 10545/9)	Resistenza agli attacchi chimici Chemical resistance (UNI EN ISO 10545/13)
passes	passes	passes	passes
Resistenza alle macchie Stain resistance (UNI EN ISO 10545/14)	Resistenza dei colori alla luce Colour resistance to light exposure (DIN 51094)	Assenza Pb Cd Absence of Pb CD (UNI EN ISO 10545/15)	
passes	passes	passes	
Assorbimento acqua Water absorption ASTM C373-88	Resistenza gelo Frost resistance ASTM C1026-02	Resistenza al ciclo caldo/freddo Resistance to frost/defrost cycles ASTM C1026-87	Resistenza agli sbalzi termici Thermal shock resistance ASTM C484-99
passes	passes	passes	passes

IMBALLI PACKAGING

Layout	Misure / Tessera mm inches Chip / Size mm inches	Misure / Foglio mm inches Sheet / Size mm inches	Fogli / Scatola Sheets / Box	m ² / Sq ft / Scatola Sq. / Sq ft / Box
Nova layout 1				
Nova layout 2				
Nova layout 3	38x38 mm 1 ^{1/2} x1 ^{1/2} "	327x327 mm 12 ^{7/8} x12 ^{7/8} "	10	1,07 11,52
Nova layout 4				

ogni layout può venire realizzato sia in tinta unita (10 colori a disposizione) che a colori miscelati / each layout can be created using both solid colours (10 colours available) and mixed colours



NOVACRONO

GIUGIARO
DESIGN

mosaico+

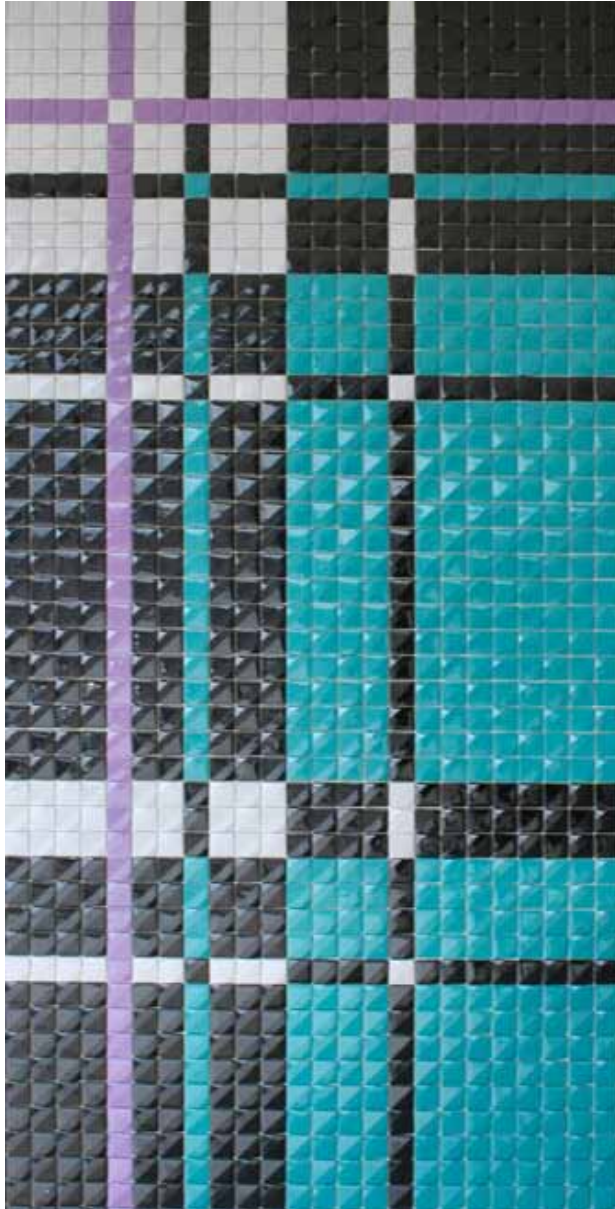

Tartan Nova

NOVA LAYOUT 4

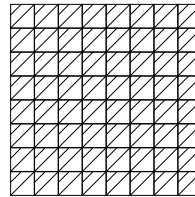

327x327 mm 12^{7/8}x12^{7/8}"

IMBALLI PACKAGING

Layout	Misure / Tessera mm inches Chip / Size mm inches	Misure / Foglio mm inches Sheet / Size mm inches	Misure / Modulo mm inches Module / Size mm inches	Fogli / Scatola Sheets / Box	m ² Sq ft / Scatola Sq.m. Sq ft / Box
Tartan Nova Nova Layout 4	38x38 mm 1 ^{1/2} x1 ^{1/2} "	327x327 mm 12 ^{7/8} x12 ^{7/8} "	327x327 mm 12 ^{7/8} x12 ^{7/8} " 3x6 fogli / 3x6 sheets	-	1,84 mq 19,80 Sq ft

+ green

Gli investimenti in “green ecology”, l’ottimizzazione dei processi produttivi per incrementare il risparmio energetico, la ricerca di materie prime a ridotto impatto ambientale e la produzione di mosaici in vetro sinterizzato ad alta resistenza, ottenuti dal riciclo di prodotti vetrosi, caratterizzano la scelta di Mosaico+ verso una vera e propria direzione sostenibile: nel rispetto della qualità del prodotto, della tutela ambientale e con l’obiettivo di anticipare sempre la ricerca e la sperimentazione di nuove tecnologie.

Investments in “green ecology”, optimisation of production processes to increase energy saving, research into raw materials with the lowest environmental impact, and the production of high-strength sintered glass mosaics made by recycling glass products, all reflect Mosaico+’s genuine prioritisation of sustainability, with the aim of achieving product quality, safeguarding the environment and constantly developing and trialling new technologies.



green
product

95% recycled
glass



NOVACRONO



PULSARCRONO

