

ROMA

Eterna bellezza



FAP
CERAMICHE
Naturalmente casa.

ROMA

Eterna bellezza

10

STATUARIO

40

GRAFITE

52

TRAVERTINO

60

PIETRA

70

IMPERIALE

84

CALACATTA





WALL & FLOOR

Roma è un progetto ceramico completo di pavimenti e rivestimenti per circondare di bellezza i vostri spazi.

Roma is a complete ceramic programme of floor and wall tiles to encase your rooms with a sensation of beauty.

Roma représente un projet céramique complet composé de sols et de murs qui saura valoriser vos espaces de vie. / Roma ein vollständiges Keramikprojekt für Fußböden und Verkleidungen der Ihren Raum mit Schönheit umgibt. / Roma es un proyecto cerámico completo de pavimentos y revestimientos para inundar vuestros espacios de belleza. / Roma — это универсальный проект напольной и настенной плитки, привносящей в ваш дом истинную красоту.

MARMO E PIETRA MARBLE & STONE

Roma esprime con fascino contemporaneo la bellezza del marmo e della pietra. Sei colori interpretano con grandi lastre una nuova estetica progettuale, senza limiti, senza tempo.

Roma lends contemporary appeal to the beauty of marble and stone. Six colours and large slabs for a new aesthetic project that is timeless and knows no limits.

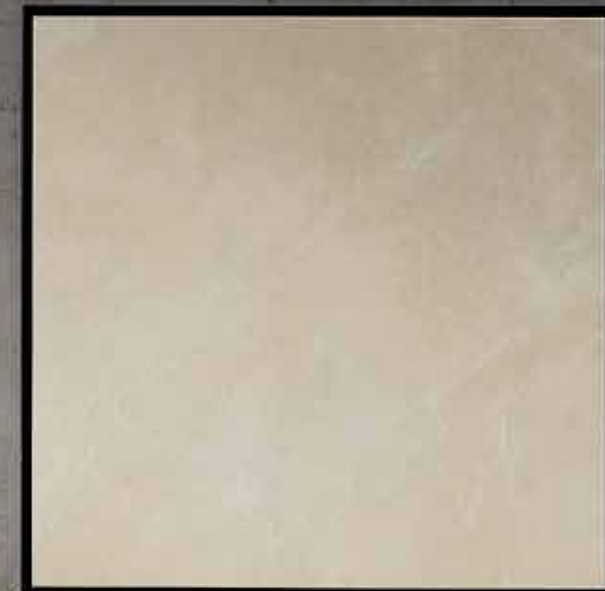

MARBRE ET PIERRE. Roma exprime la beauté du marbre et de la pierre avec un charme contemporain. Sur de grandes plaques, six couleurs interprètent une nouvelle esthétique conceptuelle, sans limite et sans contrainte. / MARMOR UND STEIN. Roma bringt die Schönheit des Marmors und des Steins mit zeitgemäßen Charme zum Ausdruck. Sechs Farben interpretieren mit großen Platten eine neue Planungästhetik, grenzenlos und zeitlos. / MARMOL Y PIEDRA. Roma refleja con un moderno atractivo la belleza del mármol y de la piedra. Seis colores interpretan junto con grandes losas una nueva estética proyectual sin límites ni tiempo. / Мрамор и КАМЕНЬ. Roma передает в современном ключе красоту мрамора и камня. В шести тональностях крупноформатной плитки выражена новая дизайнерская эстетика: без границ и вне времени.

PAVIMENTI MATT E LUX MATT & LUX FLOOR

*Due superfici, due sensazioni:
Matt per un effetto sofisticato
e contemporaneo, Lux per un
risultato morbido, leggermente
cerato.*

*Two finishes, two sensations: Matt
for a sophisticated and contem-
porary effect, Lux for a soft and
lightly waxed effect.*

SOLS MATT ET LUX. Deux surfaces,
deux sensations : Matt pour un effet
sophistiqué et contemporain, Lux pour
un aspect doux, légèrement ciré. /
FUSSBODEN MATT UND LUX. Zwei
verschiedene Oberflächen, zwei ver-
schiedene Empfindungen: Matt für ein
anspruchsvollen und zeitgemäßen
Effekt, Lux für ein sanftes Ergebnis
welches leicht eingewachst wirkt. /
PAVIMENTOS MATT Y LUX. Dos su-
perficies, dos sensaciones: Matt para
un efecto sofisticado y moderno; Lux
para un resultado suave, ligeramente
encerado. / НАПОЛЬНАЯ ПЛИТКА
МАТТ И LUX. Две поверхности,
два ощущения: Матт - изысканный
современный эффект, Lux — эффект
мягкости и легкого вощения.

MATT



LUX

STATUARIO

puro e perfetto / pure and perfect

pur et parfait
Perfekt und rein
puro y perfecto
чистая и безупречная

PASTA BIANCA
WHITE BODY



50x110 RT

50x110 RT

50x110 RT

25 x 75

25 x 75

25 x 75

GRES PORCELLANATO
PORCELAIN STONEWARE



75x150 RT

75x75 RT

60 x 60 RT

30x60 RT

ATELIER



21,6x25

20x20

7,5x30



MY LIVING

75x150 e 50x110, pavimento e rivestimento, il puro fascino dello Statuario e del grande formato.

75x150 and 50x110, wall and floor coverings, the pure attraction of Statuario and large size.



75x150 et 50x110, sols et murs, le charme de Statuario et du grand format à l'état pur. / 75x150 und 50x110, Fußboden und Wandverkleidung, der reine Charme des Statuario und des großen Formats. / 75x150 y 50x110, pavimento y revestimiento, la atracción pura del Statuario y del gran formato. / 75x150 и 50x110, настенная и напольная плитка, непревзойденное очарование линии Statuario и крупного формата.

Wall
Roma Fold Statuario

Floor
Roma Statuario Lux



Wall
Roma Statuario
Roma Filo Statuario

Floor
Roma Statuario Lux

Project on page 107

LA SUPERFICIE DECORA SURFACES FOR DECORATION

*Tridimensionale nella struttura Filo, o elegante fondo, è sempre la materia la vera decorazione.
Whether it is the three dimensional texture of Filo or the elegant tile, the real decoration is always the material.*



C'EST LA MATIERE QUI DECORE. Tridimensionnel dans sa structure Filo, ou élégante base unie, c'est la matière qui constitue la véritable décoration. / DIE OBERFLÄCHE DEKORIERT. Das 3D- Dekor Filo oder eine elegante Grundfliese, die Dekoration liegt immer in der Materie. / LA SUPERFICIE DECORA. Tridimensional en la estructura Filo, o fondo elegante, la materia resulta ser siempre la auténtica decoración. / ПОВЕРХНОСТЬ УКРАШАЕТ. Объемная структура Filo или элегантная фоновая плитка — в центре внимания неизменно сам материал.



*Mosaico Natura,
listello cromato Silver
e il formato del rivesti-
mento 25x75 rendono
tutto contemporaneo.*

*Natura Mosaic, Silver
chrome listel and the
25x75 wall covering
shape make everything
look contemporary.*

Mosaïque Natura, listel chromé Silver et format 25x75 au mur, une association qui apporte à l'espace une réelle touche de modernité. / Mosaik Natura, die verchromte Leiste Silver und die Wandverkleidung im Format 25x75 lassen alles zeitgemäß erscheinen. / Mosaico Natura, listello cromato Silver y el formato del revestimiento 25x75 confieren siempre modernidad. / Мозаика Natura, хромированный бордюр Silver и формат настенной плитки 25x75 преобразуют помещение в современном стиле.

Wall
Roma Statuario
Roma Natura
Statuario Mosaico

Project on page 108



THE RESTAURANT

Il fascino intramontabile dell'esagono interpretato anche nella raffinata versione Decò.

The timeless appeal of the hexagon is also interpreted in the sophisticated Decò version.



Le charme indémodable de la forme hexagonale décliné dans l'élégante version Decò. / Der unvergängliche Charme des Sechseckformats, interpretiert in der raffinierten Version Decò. / La atracción imperecedera del hexágono interpretada también en la refinada versión Decò. / Непревзойденное очарование шестиугольника в утонченной версии Decò.



Stair
Roma Statuario

Floor
Roma Grafite

UNA MATERIA SENZA TEMPO

A TIMELESS MATERIAL

Una gamma completa di pezzi speciali per coordinare perfettamente ogni ambiente della casa. Pavimento, scalino e battiscopa.

A full range of trim tiles to coordinate all the spaces in the home to perfection. Flooring, step and skirting tiles.

UNE MATIÈRE INTEMPORELLE. Un programme complet de pièces spéciales pour revêtir à la perfection chaque espace de la maison. Sol, marche et plinthe. / EINE ZEITLOSE MATERIE. Eine vollständige Auswahl von Spezialteile für eine perfekte Raumkoordination Ihres Heims. Fußboden, Stufe und Fußleiste. / UNA MATERIA A TEMPORAL. Una gama completa de piezas especiales para coordinar a la perfección cada ambiente de la vivienda. Pavimento, escalera y zócalo. / НЕПРЕХОДЯЩАЯ МАТЕРИЯ. Идеальное завершение всех помещений вашего дома благодаря полной гамме специальных элементов. Напольная плитка, ступенька и плинтус.



Floor
Roma Ottagono Statuario
Roma Tozzetto Grafite

Affascinanti venature naturali, sofisticate geometrie tridimensionali e la raffinatezza dell'inserito Dark: questa è eleganza.

Attractive natural veining, sophisticated three dimensional patterns and the classy Dark insert: this is elegance.



Wall

Roma Statuario
Roma Fold Statuario
Roma Dark Inserto

Floor

Roma Statuario Lux

Project on page 109

De fascinantes veinures naturelles, des reliefs géométriques recherchés, l'insert d'une grande finesse: c'est de l'élégance. / Bezaubernde natürliche Verläufe, raffinierte 3D-Geometrien und die Feinheit des Einsatzes Dark: das ist Eleganz. / Magníficas vetas naturales, sofisticadas geometrías tridimensionales y el refinado inserto Dark son pura elegancia. / Сама элегантность в восхитительных естественных прожилках, изящных трехмерных геометрических мотивах и в утонченном декоре Dark.



Wall
Roma Statuario
Roma Brick Grafite Mosaico

Floor
Roma Grafite

Project on page 110



Molteplici formati, creati con la stessa materia, si uniscono per comporre un personale progetto di stile.

A variety of shapes created with the same material and combined to create a personal style project.



Une multitude de formats, tous composés de la même matière, s'unissent pour composer un projet de style personnel. / Eine Vielfalt an Formate erzeugt aus derselben Materie vereinen sich und formen ein stilvolles und persönliches Projekt. / Múltiples formatos, creados con la misma materia, se amalgaman para componer un personal proyecto de estilo. / Многочисленные форматы, созданные из одинакового материала, соединяются в едином проекте, передающем индивидуальный стиль.



ROUND MARBLE



Wall
Roma Statuario
Floor
Roma Righe Statuario Grafite Matt

SHOP SIMPLY CHIC

*Una grande bellezza per realizzare spazi commerciali contemporanei.
Il vero lusso: personalizzarli con sofisticate decorazioni.*

*True beauty for contemporary commercial applications.
True luxury: customisation with sophisticated decorations.*



Le maximum de l'esthétique pour réaliser des espaces commerciaux contemporains. Et pour encore plus de classe, apportez leur une touche de personnalité avec quelques décors. / Eine wunderbare Schönheit für die Erschaffung von zeitgemäßen kommerziellen Räumlichkeiten. Der wahre Luxus: Personalisierung mit raffinierten Dekorationen. / Una gran belleza para realizar espacios comerciales contemporáneos. El auténtico lujo: personalizarlos con sofisticadas decoraciones. / Красота стиля для реализации современных деловых помещений. Придание индивидуальности благодаря изысканным декорам — это настоящая роскошь.



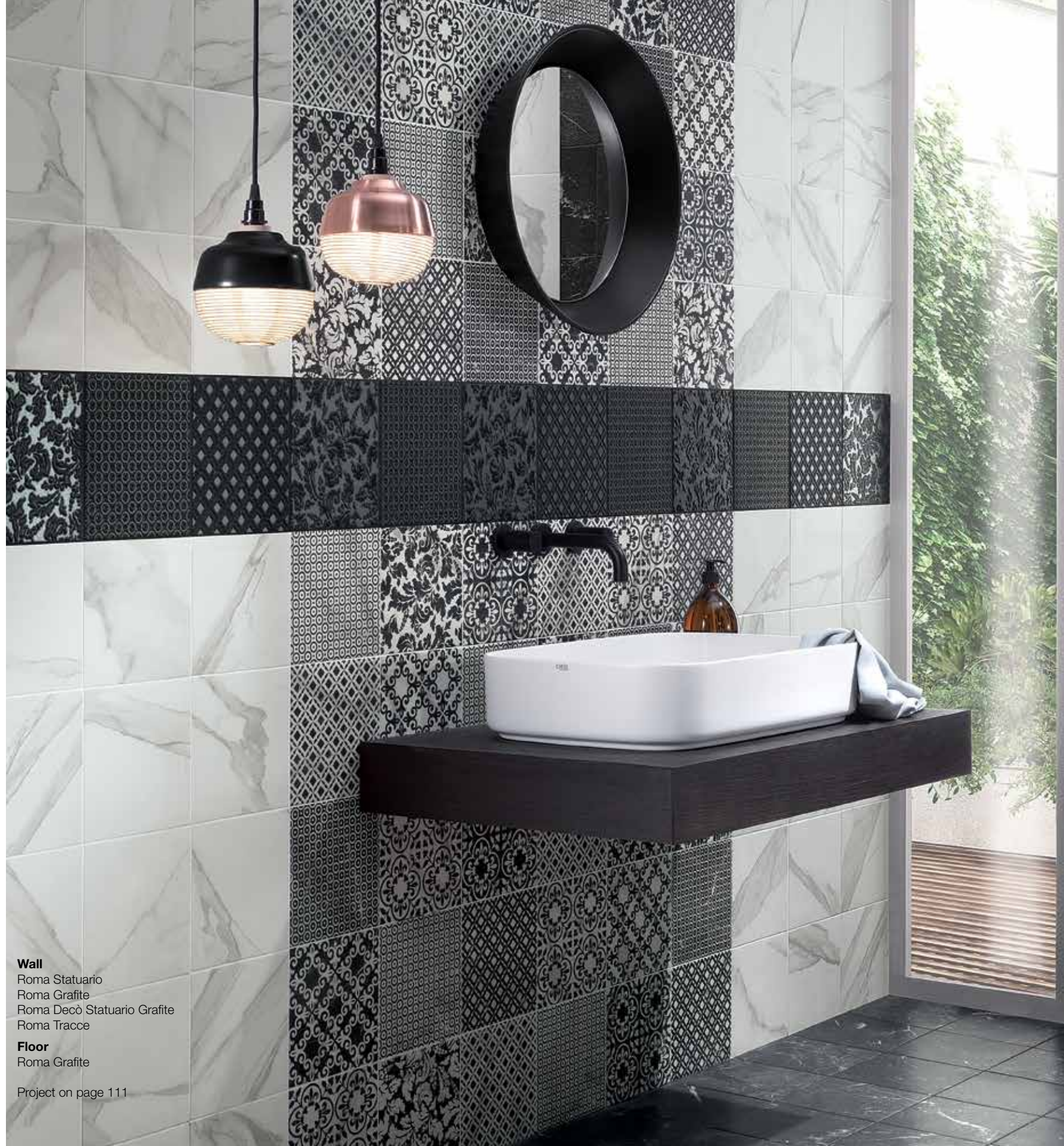

*Essenziale e raffinato
il bianco e nero,
ricercati e cesellati i
decori Tracce e Decò.*

*Essential and elegant
black and white, the
sought-after chiselled
Tracce and Decò
decorations.*

Wall

Roma Statuario
Roma Grafite
Roma Decò Statuario Grafite
Roma Tracce

Floor

Roma Grafite

Project on page 111

Le noir et le blanc: essentiel et toujours très raffiné, comme le sont également les décors ciselés Tracce et Decò. / Essentiell und raffiniert das Weiß und Schwarz, ausgesuchte und kunstvoll ausgearbeitete Dekorationen Tracce und Decò. / Esencial y elegante el blanco y negro, minuciosas decoraciones cinceladas Tracce y Decò. / Строгое и утонченное черно-белое решение, изысканные и четкие декоры Трассе и Деко.

GRAFITE

elegante e profondo / elegant and profound

élégant et profond
Elegant und tief
elegante y profundo
элегантная и глубокая

GRES PORCELLANATO
PORCELAIN STONEWARE



75 x 150 RT

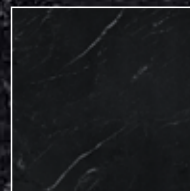

75 x 75 RT



60 x 60 RT

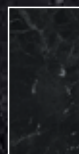

30 x 60 RT

ATELIER



21,6 x 25



20 x 20



7,5 x 30

HOME

*Greca Mosaico e 20x20 senza tempo nell'ingresso. 75x150 una soluzione di continuità in cucina.
Mosaic border and the timeless 20x20 in the entrance hall. 75x150 a seamless solution in the kitchen.*



Greca mosaico et 20x20, de grands classiques indémodables dans l'entrée; 75x150, en contraste dans la cuisine. / Greca Mosaico und 20x20 zeitlos im Vorraum. 75x150 als Kontinuitätslösung in der Küche. / Greca Mosaico y 20x20 atemporal en la entrada. 75x150 una solución de continuidad en la cocina. / Коридор выложен неувядающей Мозаикой Greca и плиткой формата 20x20. Формат 75x150 — решение в едином стиле для кухни.



RELAXING



SHOPPING

ELEGANT CONTEMPORARY

La seduzione del marmo e l'affidabilità del gres porcellanato: partner perfetti per locali esclusivi.

The seduction of marble and the reliability of porcelain stoneware: ideal partners for exclusive spaces.



Wall

Roma Statuario

Floor

Roma Grafite Lux

La séduction du marbre et la fiabilité du grès cérame : des partenaires parfaits pour des espaces exclusifs. / Die Verführung des Marmors und die Zuverlässigkeit des Feinsteinzeugs: Perfekte Partner für exklusive Räume. / La seducción del mármol y la fiabilidad del gres porcelánico: excelente combinación para locales exclusivos. / Очарование мрамора и надежность керамогранита: идеальное сочетание для оформления эксклюзивных помещений.



Wall
Roma Grafite
Roma Raku Listello

Floor
Roma Statuario Lux

Project on page 112

COOL

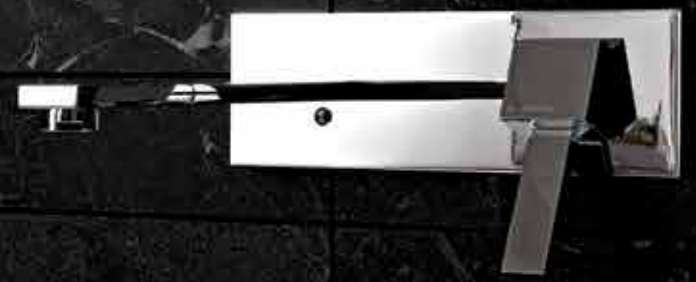

TRAVERTINO

ricco e naturale / rich and natural

riche et naturel
Reich und natürlich
rico y natural
роскошная и естественная

PASTA BIANCA
WHITE BODY



50x110 RT 50x110 RT 25x75 25x75

GRES PORCELLANATO
PORCELAIN STONEWARE



75x150 RT 75x75 RT 60x60 RT 30x60 RT



Wall
Roma Travertino
Roma Filo Travertino
Roma Natura Travertino Mosaico

Floor
Roma Travertino Matt

Project on page 113

FASCINO NATURALE NATURAL ATTRACTION

Naturali striature, nel formato 50x110, circondano lo spazio. Nella doccia, il mosaico Natura e la versatile materia esprimono soluzioni architettoniche affascinanti.

Natural veins, in the 50x110 size, encasing the space. In the shower, the Natura mosaic and the versatile material express attractive architectural solutions.



CHARME NATUREL. Les striures naturelles présentes sur le format 50x110 entourent l'espace. Dans la douche, la mosaïque Natura et la matière très éclectique donnent naissance à des solutions architecturales particulièrement intéressantes. / NATÜRLICHER CHARME. Natürliche Verläufe im Format 50x110 umgeben den Raum. In der Dusche strahlen das Mosaik Natura und die vielseitige Materie charmante architektonische Lösungen aus. / ATTRACTIVO NATURAL. Vetas naturales en el formato 50x110 rodean el espacio. En la ducha, el mosaico Natura y la versátil materia muestran excelentes soluciones arquitectónicas. / ОЧАРОВАНИЕ ПРИРОДЫ. Естественное рифление формата 50x110 наполняет пространство. В душевой кабине мозаика Natura и многофункциональная керамика воплощают восхитительные архитектурные решения.



GLAM GYM

*Atmosfera sofisticata,
sensazioni naturali.*

*Sophisticated atmosphere,
natural sensations.*

Wall
Roma Travertino

Floor
Roma Travertino

Une atmosphère captivante,
des sensations naturelles. /
Raffinierte Atmosphäre, natür-
liche Sensationen. / Atmós-
fera sofisticada, sensaciones
naturales. / Утонченная
атмосфера, соприкосновение с
природой.

PIETRA

raffinata e accogliente / elegant and inviting

raffinée et accueillante
Raffiniert und einladend
refinada y acogedora
изысканная и уютная

PASTA BIANCA
WHITE BODY



50x110 RT



50x110 RT



25x75



25x75

GRES PORCELLANATO
PORCELAIN STONEWARE



75x150 RT



75x75 RT



60x60 RT



30x60 RT



Wall
Roma Pietra
Roma Filo Pietra
Roma Pietra Mosaico

Floor
Roma Pietra Matt

Project on page 114



Differenti e morbide vibrazioni di luce decorano la materia in un mood perfettamente coordinato.

The soft and changing shimmering light decorates the material with a mood that is perfectly coordinated.



Des reflets de lumière, doux et ondoyants, animent cet espace ou tout apparait coordonné avec juste équilibre. / Verschiedene und sanfte Vibrationen von Licht schmücken die Materie in einem perfekt koordinierten Mood. / Distintas vibraciones suaves de luz decoran la materia con un estilo perfectamente coordinado. / Разнообразные мягкие световые блики придают плитке безупречное единство стиля.



Wall
Roma Pietra
Roma Classic Pietra
Roma Classic Pietra Listello
Floor
Roma Pietra Matt

Project on page 115

NEW CLASSIC



L'eleganza tridimensionale del decoro Classic sul calore screziato della Pietra: un nuovo classico che sorprende per contemporaneità.

The three dimensional elegance of the Classic decoration on the grainy warmth of Pietra: a new classic whose contemporary mood is astonishing.

L'élégance et le chic du relief du décor Classic en opposition à l'ardeur jaspée de Pietra : un classique insolite qui surprend par sa modernité. / Die 3D-Eleganz des Dekors Classic auf dem natürlichen Farbverlaufs des Pietra: ein neuer Klassiker, der mit seinem modernen Einklang überrascht. / La elegancia tridimensional de la decoración Classic en el cálido vetado de la Pietra: un nuevo clásico que sorprende por su modernidad. / Элегантность трехмерного декора Classic выражена теплыми крапинками Pietra: новая классика, поражающая своей современностью.

Pietra e Imperiale, un abbinamento sofisticato, esaltato dalle infinite possibilità progettuali di Roma.

Pietra and Imperiale a sophisticated combination emphasised by the infinite design possibilities of Roma.



Wall
Roma Pietra
Roma Imperiale
Roma Natura Imperiale Mosaico

Floor
Roma Imperiale Lux

Project on page 116



Pietra et Imperiale, un mariage recherché, relevé par les innombrables possibilités conceptuelles de Roma. / Pietra und Imperiale, eine raffinierte Kombination mit unendlichen Planungsmöglichkeiten von Roma. / Pietra e Imperiale, una sofisticada combinación exaltada por infinitas posibilidades proyectuales de Roma. / Pietra и Imperiale, утонченное сочетание, подчеркнутое бесконечными дизайнерскими возможностями Roma.

IMPERIALE

s sofisticato e singolare / sophisticated and unusual

sophisticé et singulier
Raffiniert und einmalig
sofisticado y singular
утонченна и уникальная

PASTA BIANCA
WHITE BODY



50x110 RT



50x110 RT



25x75

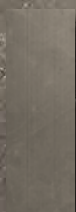

25x75

GRES PORCELLANATO
PORCELAIN STONEWARE



75x150 RT



75x75 RT



60x60 RT



30x60 RT

ATELIER



21,6x25



20x20



7,5x30

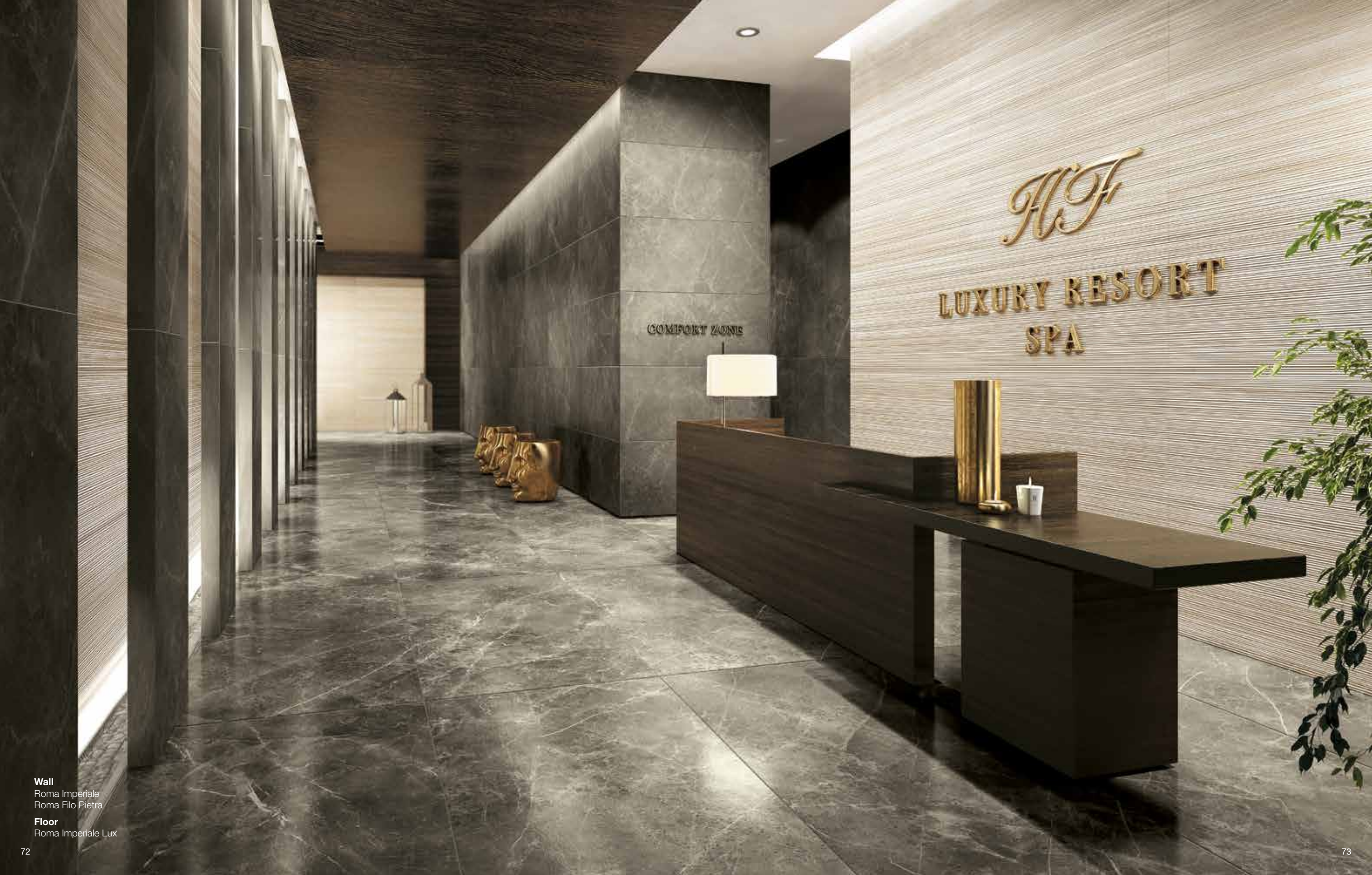

Wall
Roma Imperiale
Roma Filo Pietra
Floor
Roma Imperiale Lux



ITALIAN BEAUTY

Gli Esagoni evocano una raffinata e attuale memoria del tempo. Affascinanti e funzionali i mattoncini nella zona cottura.

Hexagons conjure up an elegant and contemporary recollection of times gone by. Attractive and practical brick shapes in the hob area.



Les hexagones rappellent le passé, tout en apparaissant très fins et très actuels. Les briquettes de la paroi anti-éclaboussures associent fonctionnalité et recherche esthétique. / Sechseckform für eine raffinierte und aktuelle Erinnerung der Zeit. Faszinierende und funktionelle Fliesen in der Kochzone. / Los Hexágonos evocan una percepción actual y elegante del pasado. Magníficos y funcionales los ladrillos de la zona cocción. / Шестиугольники создают утонченную атмосферу прошлого. Рабочая зона кухни выложена замечательными функциональными кирпичиками.

Wall
Roma Calacatta

Floor
Roma Imperiale



Una preziosa scacchiera realizzata con un sofisticato abbinamento, Imperiale e Calacatta.

A gorgeous chequerboard pattern made using the sophisticated combination of Imperiale and Calacatta.



Ce damier dégage un charme irrésistible par cette association entre Imperiale et Calacatta. / Ein wertvolles Schachbrettmuster, welches anhand eine raffinierte Zusammensetzung realisiert ist. Imperiale und Calacatta. / Un precioso tablero hecho con una sofisticada combinación, Imperiale y Calacatta. / Роскошная шахматная доска выполнена из изящного сочетания плиток Imperiale и Calacatta.

WELCOME STYLE

*Roma, la collezione perfetta per donare alla vostra accoglienza lo stile desiderato.
Roma, the ideal collection to welcome your guests in perfect style.*



Roma, la toile de fond idéale pour recevoir vos amis dans un cadre d'un grand style. / Roma, die perfekte Kollektion die Ihrem Empfang und Begrüßung den gewünschten Stil verleiht. / Roma, la colección perfecta para otorgarle a su recibimiento el estilo deseado. / Roma, идеальная коллекция для придания вашему гостеприимству индивидуального стиля

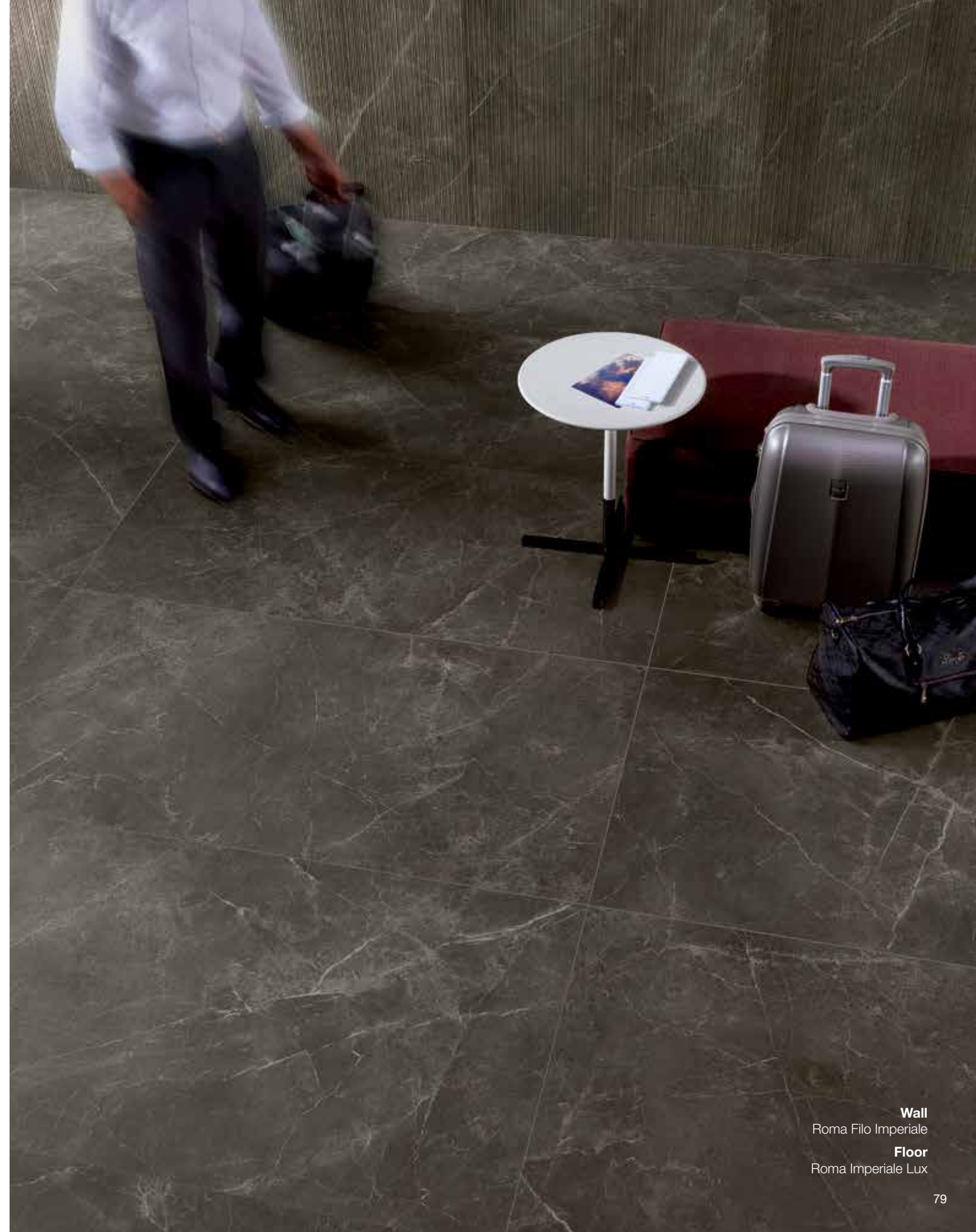

Wall
Roma Filo Imperiale
Floor
Roma Imperiale Lux



Wall
Roma Imperiale
Roma Filo Imperiale
Floor
Roma Imperiale Matt

Project on page 117

BELLEZZA AVVOLGENTE ENVELOPING BEAUTY

*Ogni lastra è un pezzo unico.
Una naturale meraviglia fatta di
differenti e spontanee venature.*

*Each slab is unique. A natural
wonder made up of different and
spontaneous veins.*



UNE BEAUTÉ CAPTIVANTE. Chaque plaque est une pièce unique. Une merveille naturelle faite de veinures variées et spontanées. / MITREISSENDE SCHÖNHEIT. Jede Platte ist einzigartig. Ein natürliches Wunder, welches aus unterschiedlichen Verläufe besteh. / ENCANTADORA BELLEZA. Cada losa es una pieza única. Una maravilla natural hecha con diferentes y espontáneas vetas. / ЧАРЮЩАЯ КРАСОТА. Каждая плитка — это уникальный элемент, будто созданный самой природой из неодинаковых произвольных прожилок.



La materia è qui protagonista come decorativo drappeggio e come elemento essenziale per un perfetto piano lavabo.

Here the material is in the spotlight in decorative folds and an essential element for a perfect top for a washbasin.



La matière joue ici un rôle de drapé décoratif et d'élément essentiel, pour un plan de toilette parfait. / Die Materie, Hauptdarsteller als dekorativer Vorhang und als essentielles Element für ein perfektes Waschbecken. / La materia es aquí protagonista como decoración drapeada y elemento esencial para una perfecta encimera de lavabo. / Материя выступает здесь и как роскошная драпировка, и как основной элемент в оформлении зоны раковины.

CALACATTA

caldo e pregiato / warm and precious

prestigieux et chaleureux
Warm und wertvoll
cálido y precioso
Теплая и драгоценная

PASTA BIANCA
WHITE BODY



50 x 110 RT

50 x 110 RT

50 x 110 RT

25 x 75

25 x 75

25 x 75

GRES PORCELLANATO
PORCELAIN STONEWARE



75 x 150 RT

75 x 75 RT

60 x 60 RT

30 x 60 RT

ATELIER



21,6 x 25

20 x 20

7,5 x 30



Wall
Roma Calacatta

Floor
Roma Calacatta Lux

RAFFINATO CALORE ELEGANT WARMTH

*75x150 Lux, la meraviglia del marmo,
la praticità del Gres porcellanato.*

*75x150 Lux, the wonder of marble, the
practical features of porcelain stoneware.*

UNE CHALEUR ENVELOPPANTE.
75x150 Lux, le charme du marbre, les
qualités pratiques du grès cérame. /
RAFFINIERTE WÄRME. 75x150 Lux,
wunderbarer Marmor und prakti-
sches Feinsteinzeug. / REFINADO
CALOR. 75x150 Lux, la maravilla del
mármol, la practicidad del Gres por-
celánico. / ИЗЫСКАННОЕ ТЕПЛО.
75x150 Lux - красота мрамора,
практичность керамогранита.



Wall
Roma Calacatta
Roma Fold Calacatta
Roma Fold Glitter Calacatta

Floor
Roma Calacatta Micromosaico

Project on page 118

PREZIOSI DECORI LUXURIOUS DECORATIONS

Calacatta, Fold e un filo di glitter dorato per creare un bagno prezioso ed essenziale.

Micromosaico dalla particolare lavorazione delle sue tessere.

Calacatta, Fold and a touch of golden glitter to create a bathroom that is luxurious and essential.

Micromosaics with tesserae made using a special process.



DE PRÉCIEUX DÉCORS. Calacatta, Fold et un fil de glitter doré pour cette salle de bains à la fois riche et essentielle. La micromosaïque est obtenue par usinage spécial des tesselles. / WERTVOLLE DEKORE. Calacatta, Fold und ein vergoldeter Glitterfaden für ein wertvolles und essentielles Bad. Mikromosaik aus besonders verarbeiteten Steinen. / EXCELENTES DECORACIONES. Calacatta, Fold y un hilo de glitter dorado para crear un baño bello y esencial. Micromosaico con una elaboración particular de sus teselas. / РОСКОШНЫЕ ДЕКОРЫ. Calacatta, Fold и немного позолоченного глиттера для создания великолепной лаконичной ванной комнаты. Микромозаика отличается оригинальной обработкой чипсов. Fold Glitter предлагается также в версии statuario 25x75.



Floor
Roma Calacatta
Roma Avana Losanga

Raffinato e decò: Roma possiede tutti gli elementi decorativi necessari per realizzare lo stile che desideri.

Elegant and decò: Roma has all the decorative elements you need to create the style you want.



Wall

Roma Calacatta Alzata
Roma Fold Calacatta
Roma Calacatta Matita
Roma Greca Calacatta Listello
Roma Calacatta
Roma Calacatta London

Floor

Roma Calacatta
Project on page 119

Raffiné et decò : Roma possède tous les éléments décoratifs nécessaires aux recherches de style les plus exigeantes. / Raffiniert und decò: Roma besitzt sämtliche dekorative Elemente für die Realisierung des gewünschten Stils. / Refinada y decò: Roma posee todos los elementos decorativos necesarios para realizar el estilo deseado. / Изысканность и decò : плитка Roma включает все декоративные элементы, необходимые для воплощения вашего персонального стиля.





Wall
Roma Calacatta
Roma Filo Calacatta

Floor
Bark Avana

Project on page 120



VERI INTARSI REAL INTARSIA

*Dalla materia incisa emergono
delicate decorazioni.*

*Delicate decorations emerge
from the engraved material.*

DE VÉRITABLES MARQUETTERIES.
De la matière incisée naissent
d'élégants décors. / ECHTE IN-
TARSIEN. Die eingravierte Materie
lässt zarte Dekorationen entstehen.
/ AUTÉNTICOS INSERTOS. De la
materia incisa emergen delicadas
decoraciones. / НАСТОЯЩАЯ
ГРАВИРОВКА. Гравированная
плитка превращается в истинное
украшение.



Inspiration rétro et expression contemporaine: une élégance indémodable. / Inspiration retrò in moderner Ausführung: immer elegant. / Inspiración retro en clave moderna, por siempre elegante. / Неувядающее ретро в современном ключе — непревзойденная элегантность.

FOREVER ELEGANT

Ispirazione retrò in chiave contemporanea: per sempre elegante.

A retro look with a contemporary mood: forever elegant.



Wall
 Roma Calacatta Alzata
 Roma Calacatta
 Roma Calacatta Matita
 Roma Calacatta London
Floor
 Roma Deco Calacatta Imperiale

Project on page 121

ROMA *Plans*



Wall A - B - D
 Roma Statuario 50x110 RT
 Roma Statuario Spigolo 1x25 RT
Floor
 Roma Statuario 75x150 RT Lux

Wall C
 Roma Filo Statuario 50x110 RT

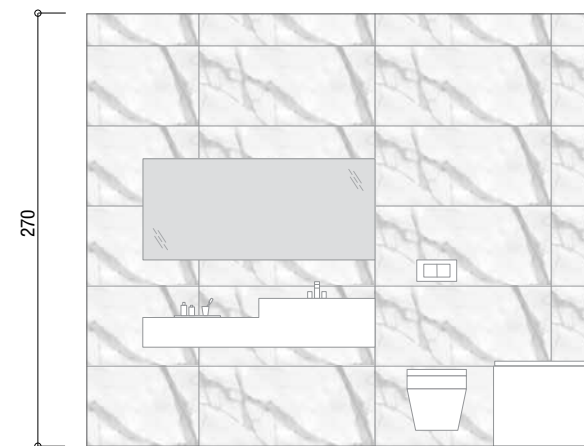
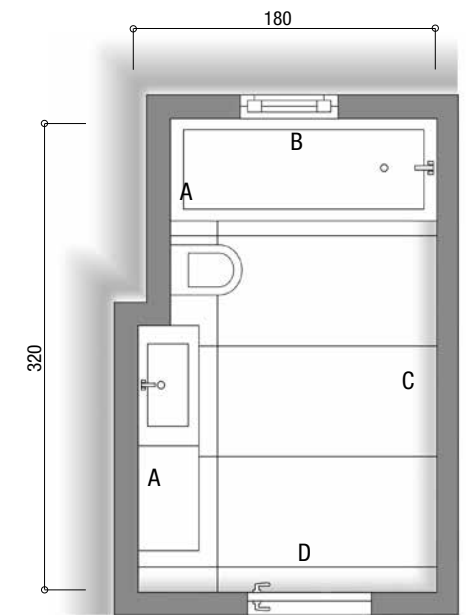

Wall A

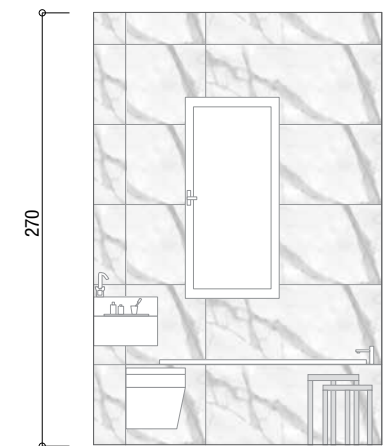

Wall B

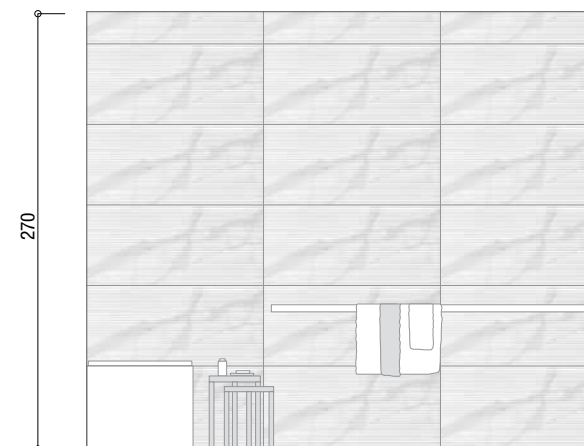

Wall C

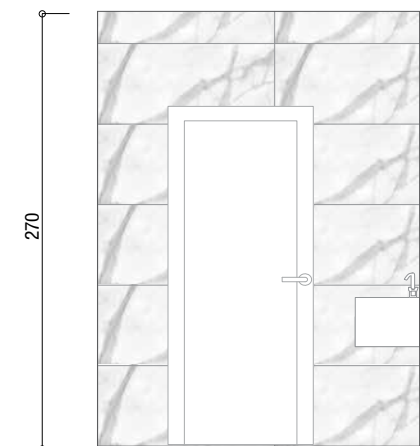

Wall D

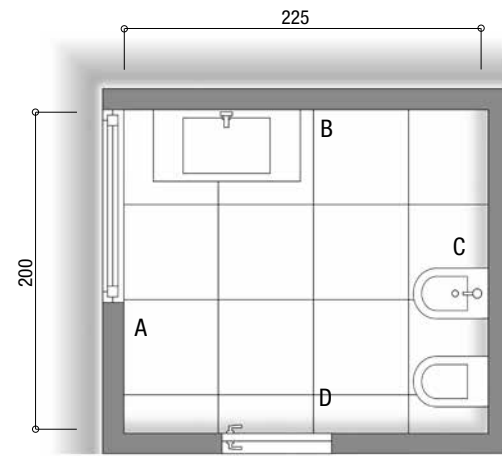

Wall A-B-C-D
 Roma Statuario 25x75
 Roma Natura Statuario Mosaico 30,5x30,5
 Lumina Silver Listello Satinato 1,5x75

Floor
 Roma Statuario 60x60 RT Matt

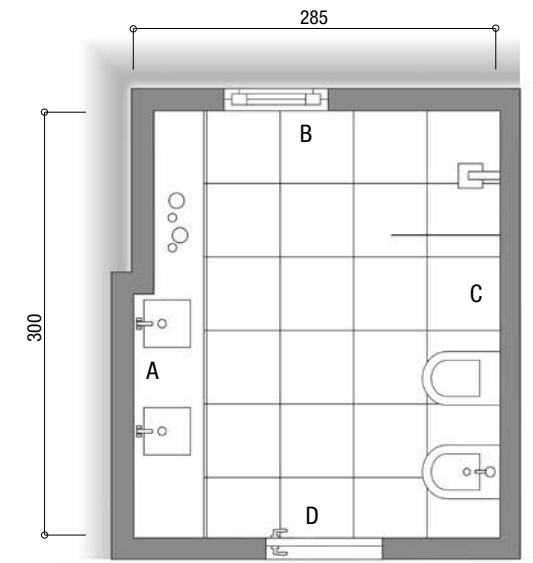

Wall A
 Roma Statuario 50x110 RT
 Roma Dark Inserto 50x110 RT
 Roma Statuario Spigolo 1x25 RT
Floor
 Roma Statuario 60x60 RT Lux

Wall B-C-D
 Roma Fold Statuario 50x110 RT

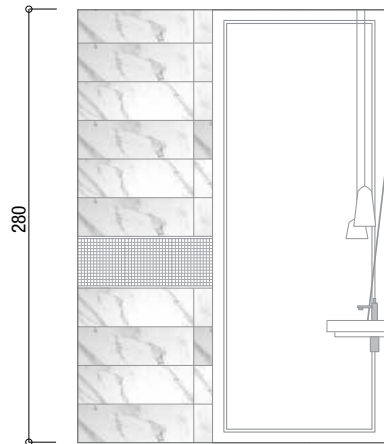

Wall A

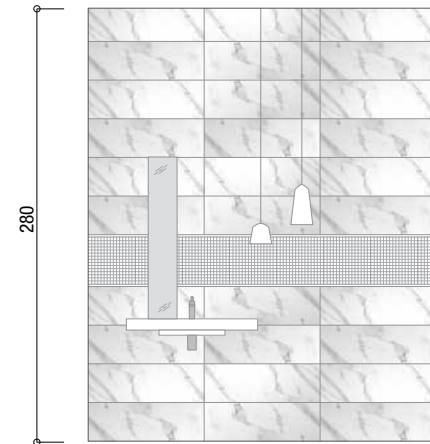

Wall B

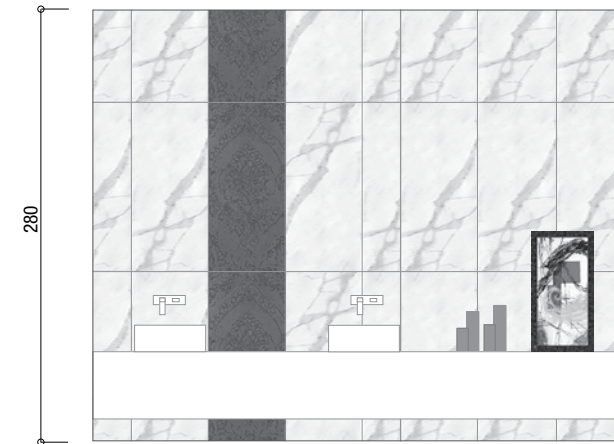

Wall A

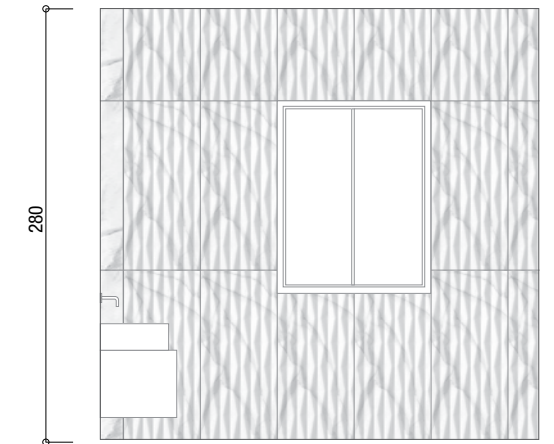

Wall B

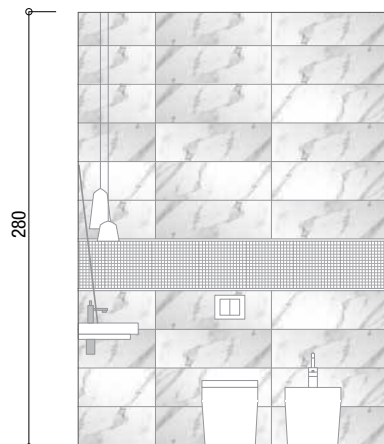

Wall C

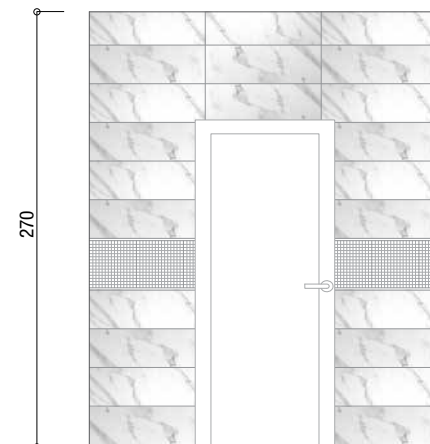

Wall D

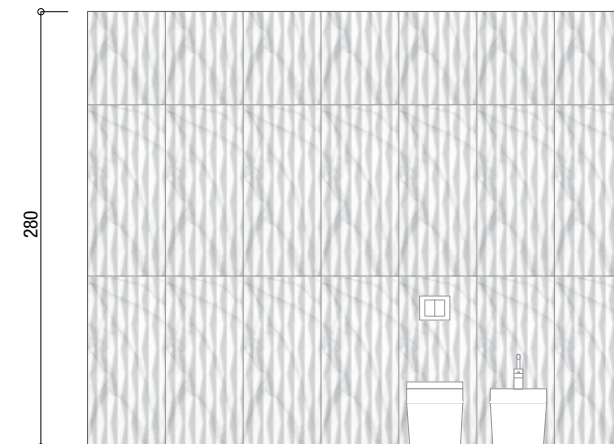

Wall C

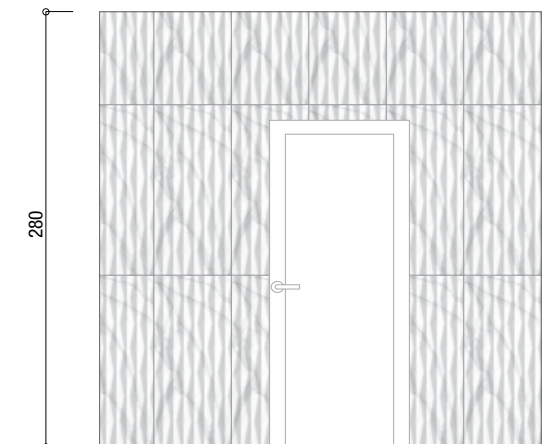

Wall D



Wall A - D
Roma Statuario 7,5x30
Floor
Roma Grafite 25x21,6

Wall B - C
Roma Statuario 7,5x30
Roma Brick Grafite Mosaico 30x30
Roma Grafite Spigolo 1x7,5 RT

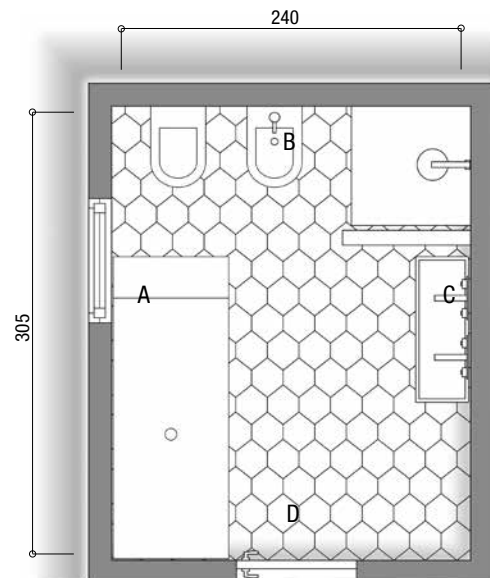

Wall A
Roma Statuario 20x20
Roma Decò Statuario Grafite 20x20
Roma Tracce Grafite Inserto 20x60
Wall C - D
Roma Statuario 20x20

Wall B
Roma Grafite 20x20
Roma Tracce Grafite Inserto 20x60
Floor
Roma Grafite 20x20

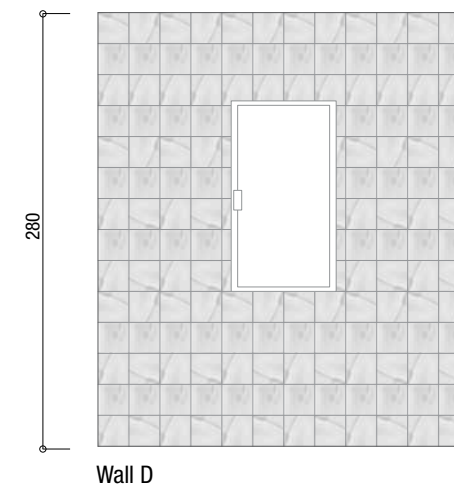
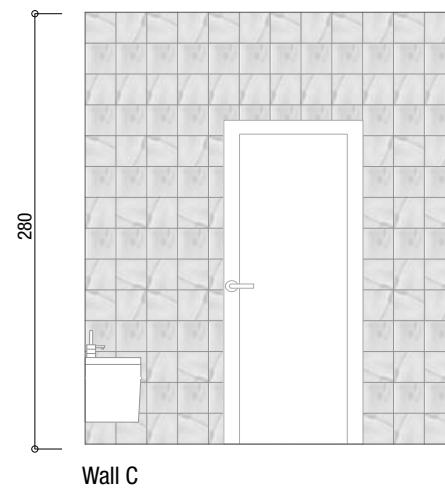
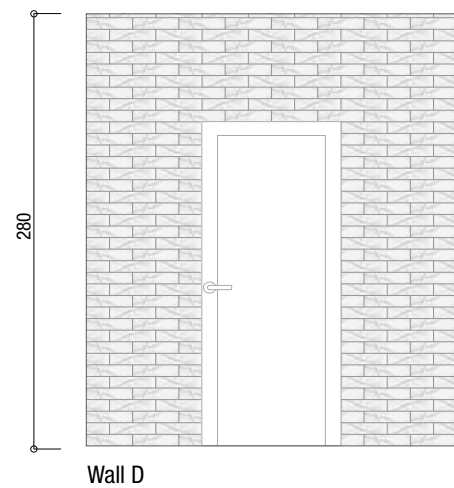
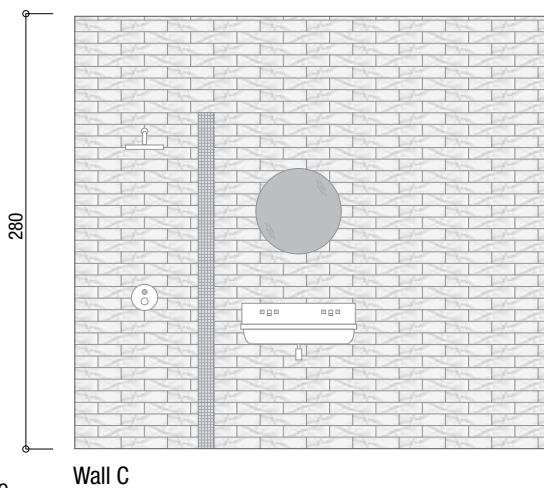
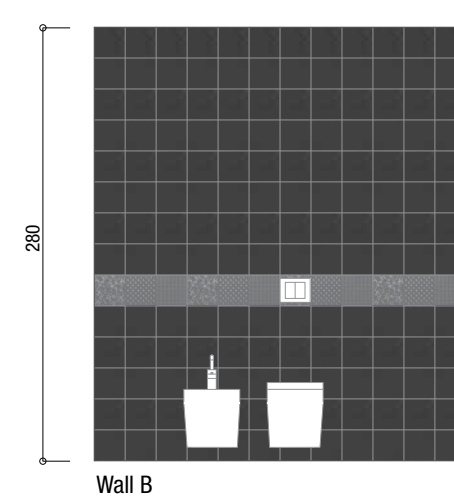
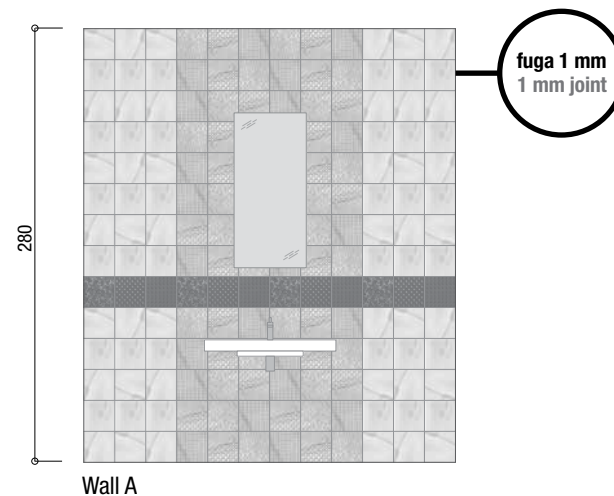
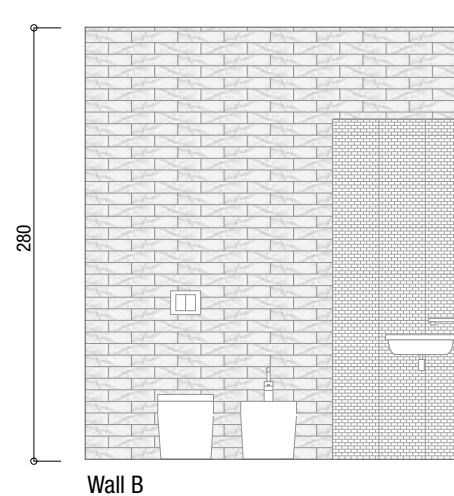
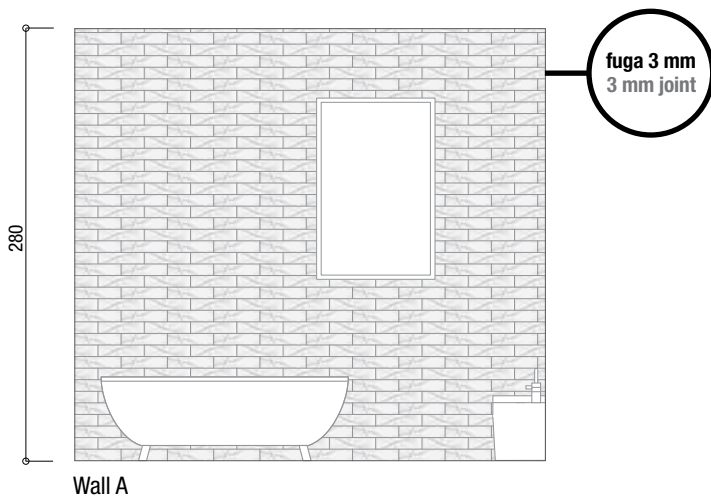
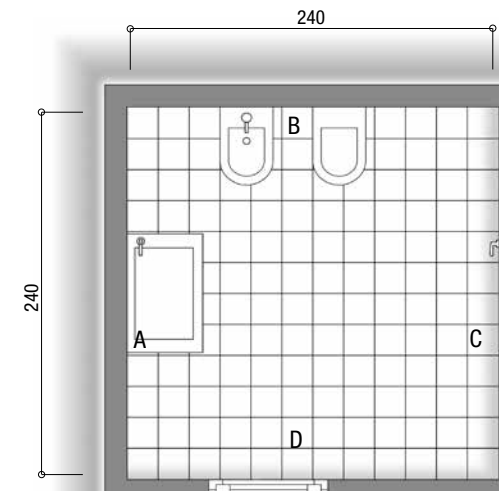

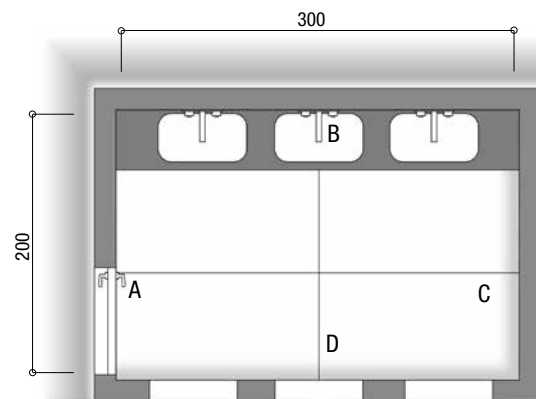

Wall A-B-C-D
 Roma Grafite 7,5x30
 Roma Raku Listello 6x25

Floor
 Roma Statuario 75x150 RT Lux

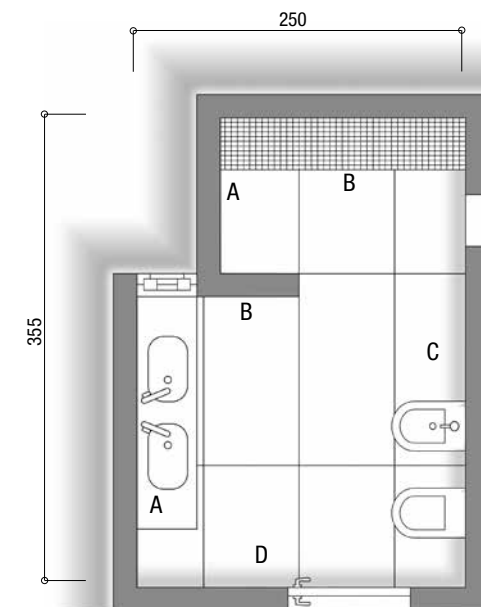

Wall A
 Roma Filo Travertino 50x110 RT
 Roma Travertino 50x110 RT
 Roma Travertino Spigolo 1x25 RT
Wall C - D
 Roma Travertino 50x110 RT

Wall B
 Roma Natura Travertino Mosaico 30,5x30,5
 Roma Travertino 50x110 RT
 Roma Travertino Spigolo 1x25 RT
Floor
 Roma Travertino 75x150 Matt

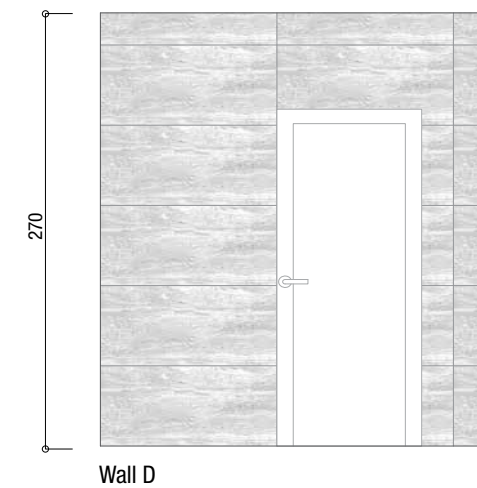
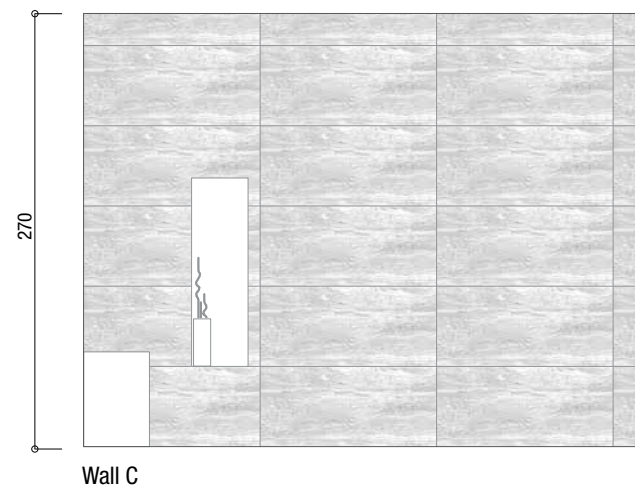
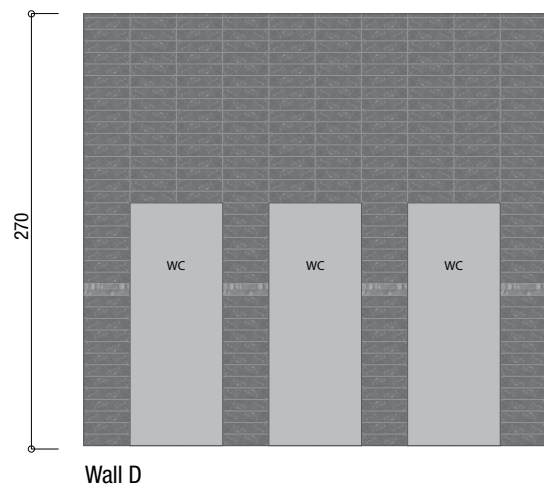
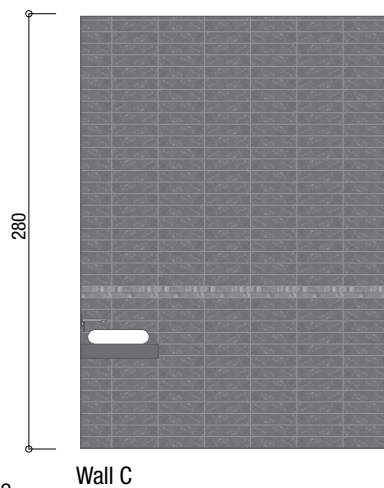
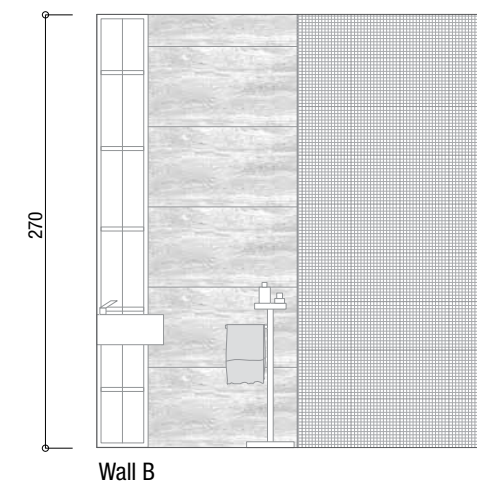
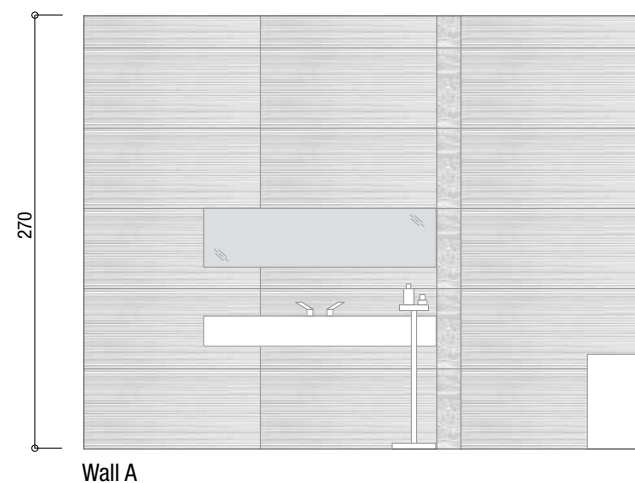
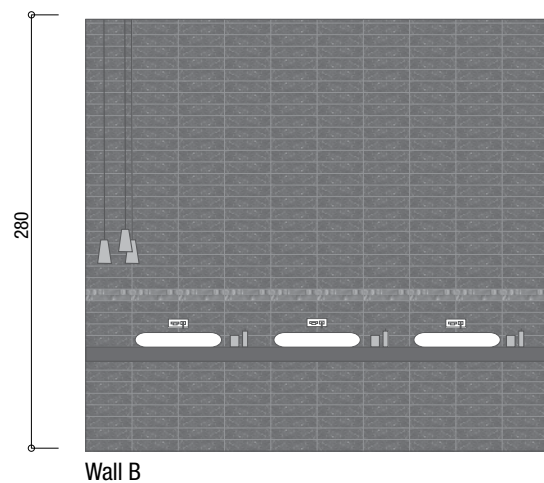
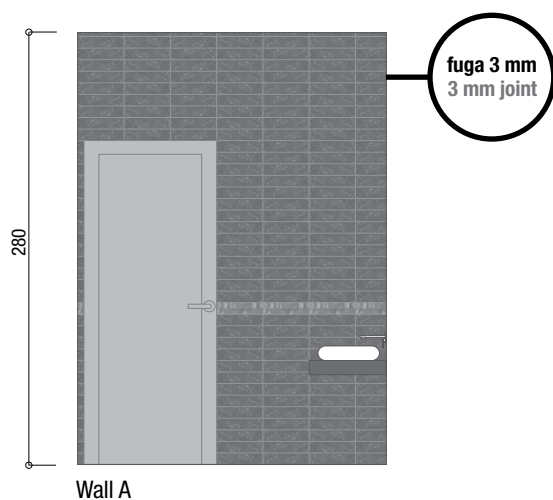

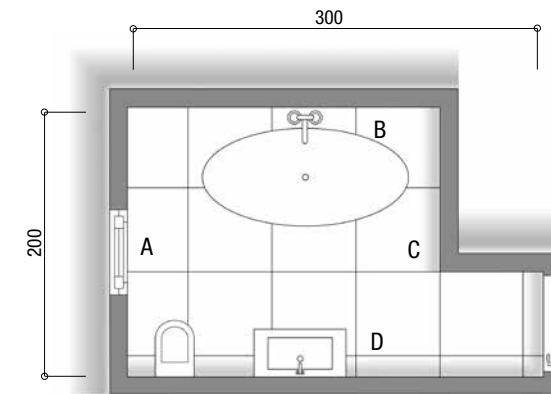
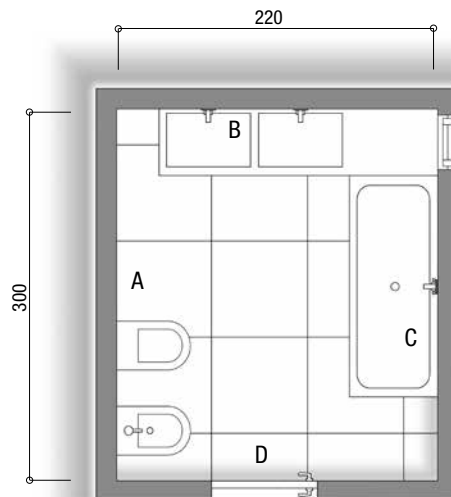

Wall A - D
Roma Pietra 50x110 RT
Wall C
Roma Pietra 50x110 RT
Roma Pietra Mosaico 30,5x30,5

Wall B
Roma Filo Pietra 50x110 RT
Floor
Roma Pietra 75x75 RT Matt

Wall B - D
Roma Pietra 25x75
Roma Classic Pietra Inserto 25x75
Roma Classic Pietra Listello 8x25
Floor
Roma Pietra 60x60 RT Matt

Wall A - C
Roma Pietra 25x75



Wall A



Wall B

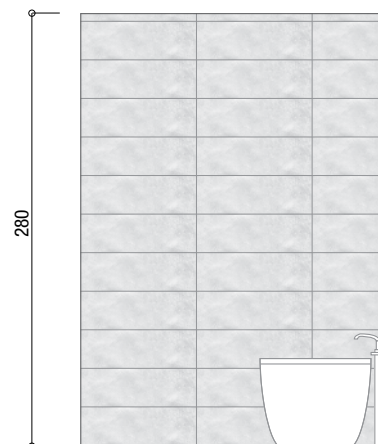

Wall A

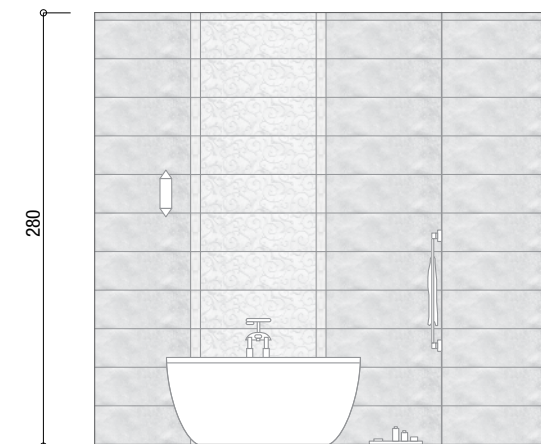

Wall B

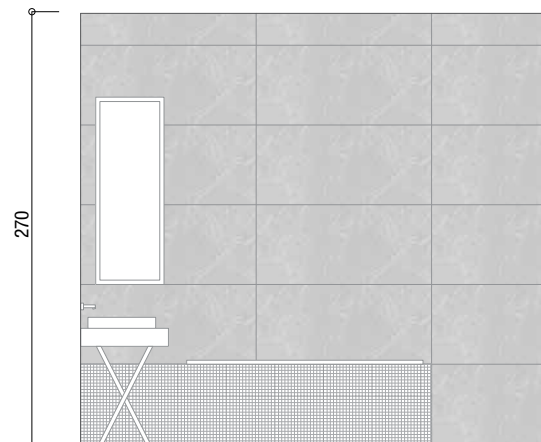

Wall C

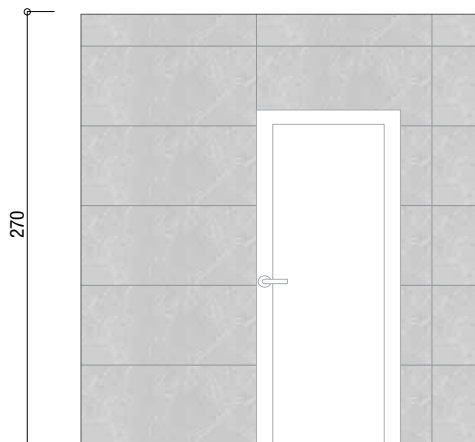

Wall D

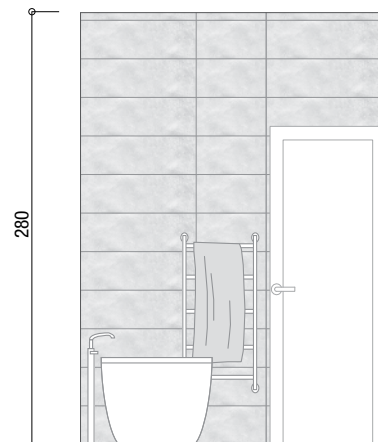

Wall C

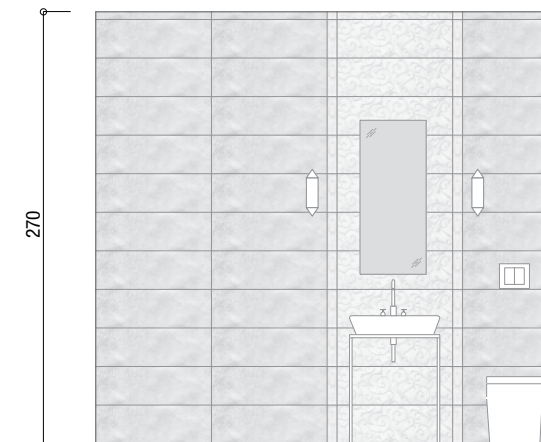

Wall D

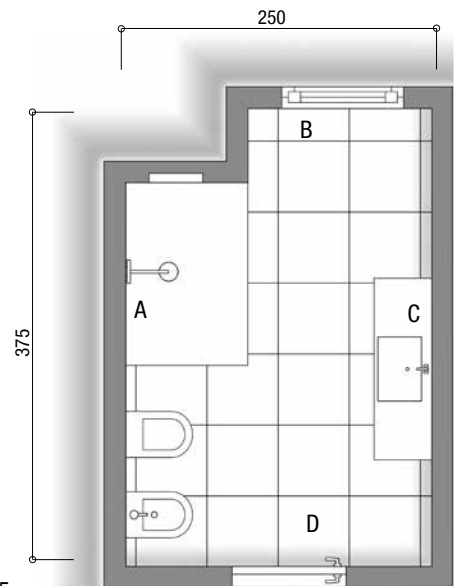

Wall A - B
 Roma Pietra 25x75
 Roma Natura Imperiale Mosaico 30,5x30,5
 Roma Pietra Spigolo 1x25 RT
Floor
 Roma Imperiale 60x60 RT Lux

Wall C
 Roma Pietra 25x75
 Roma Natura Imperiale Mosaico 30,5x30,5
 Roma Imperiale 25x75

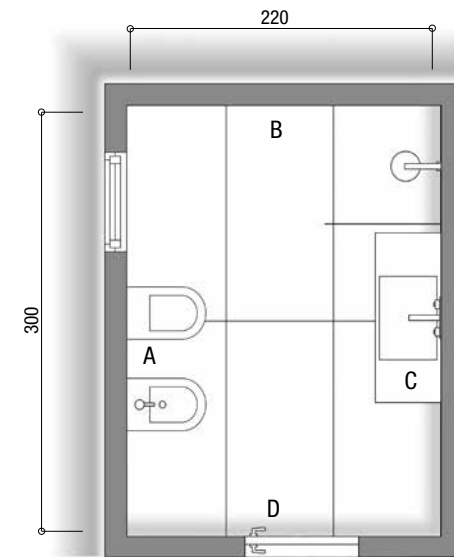

Wall A - C - D
 Roma Imperiale 50x110 RT
Floor
 Roma Imperiale 75x150 RT Matt

Wall B
 Roma Filo Imperiale 50x110 RT



Wall A

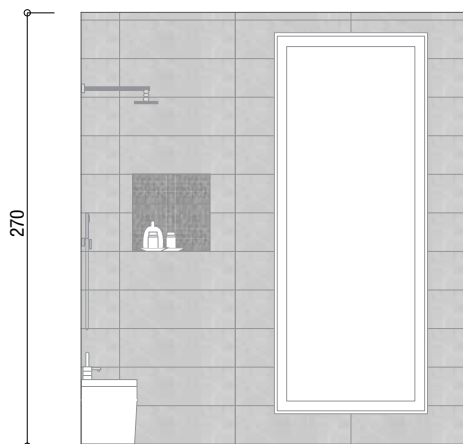

Wall B

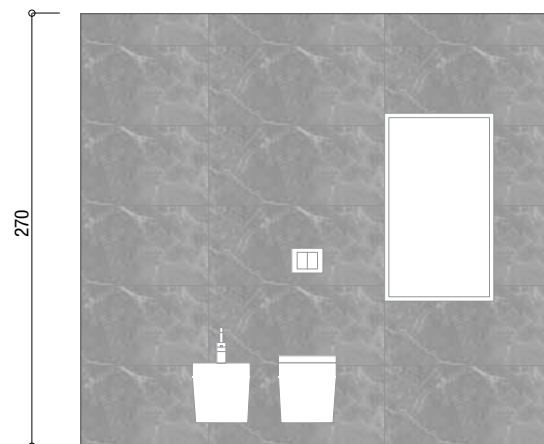

Wall A



Wall B

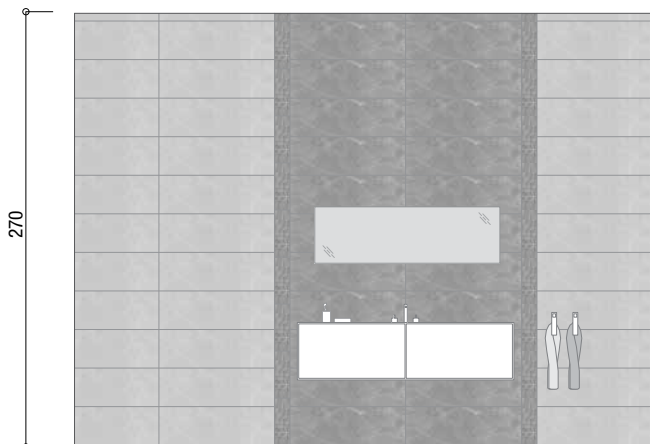

Wall C

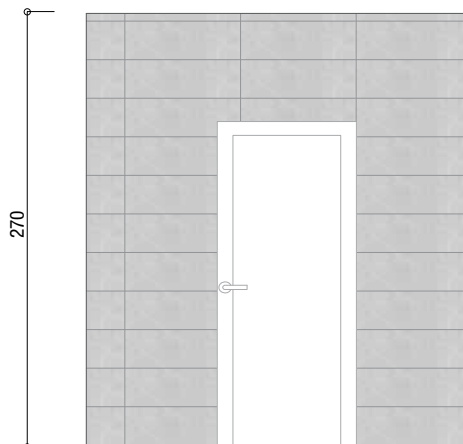

Wall D

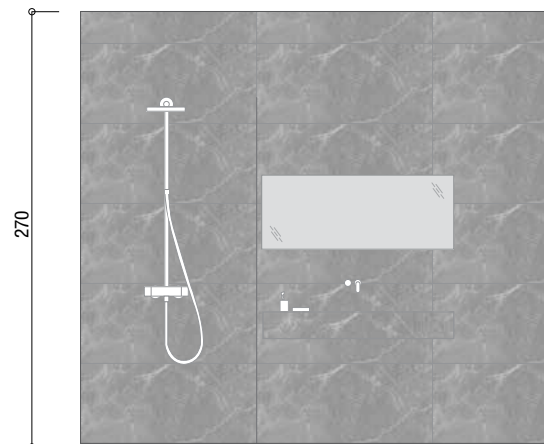

Wall C

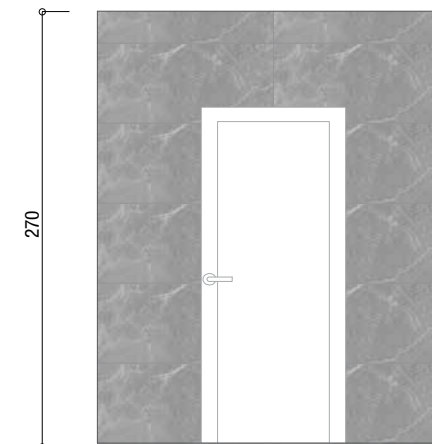

Wall D

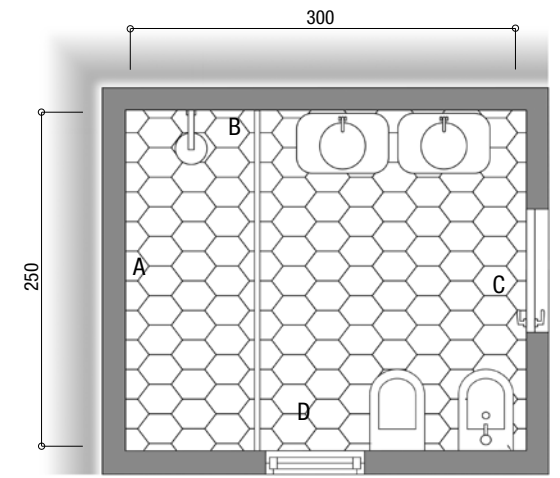
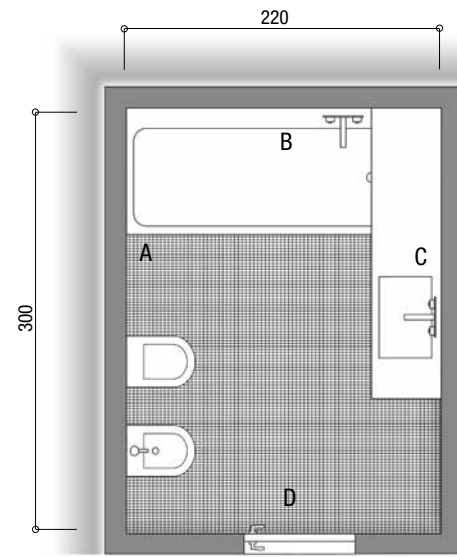

Wall A - C
 Roma Fold Calacatta 50x110 RT
 Roma Fold Glitter Calacatta 50x110 RT
Floor
 Roma Calacatta Micromosaico 30x30

Wall B - D
 Roma Calacatta 50x110 RT

Wall A-B-C-D
 Roma Calacatta Alzata 17,5x25 RT
 Roma Calacatta A.I Alzata 2x11
 Roma Calacatta Raccordo 2x25 RT
 Roma Fold Calacatta 25x75
 Roma Calacatta Matita 2x25 RT
 Roma Greca Calacatta Listello 8x25
 Roma Calacatta 25x75
 Roma Calacatta London 5,5x25 RT
 Roma Calacatta A.I London 1,5x5,5

Floor
 Roma Calacatta 25x21,6

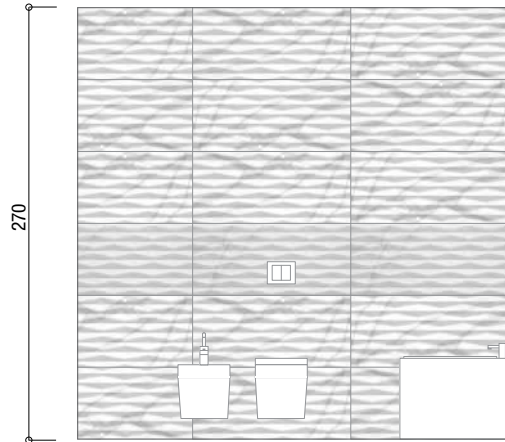

Wall A



Wall B

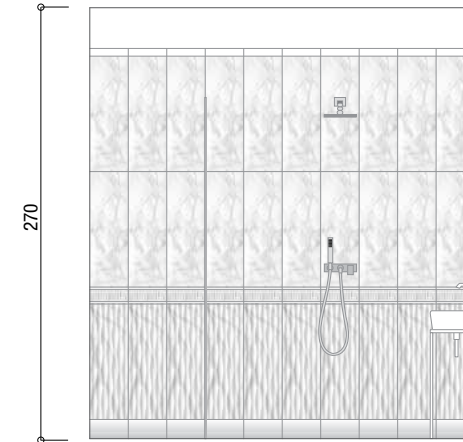

Wall A

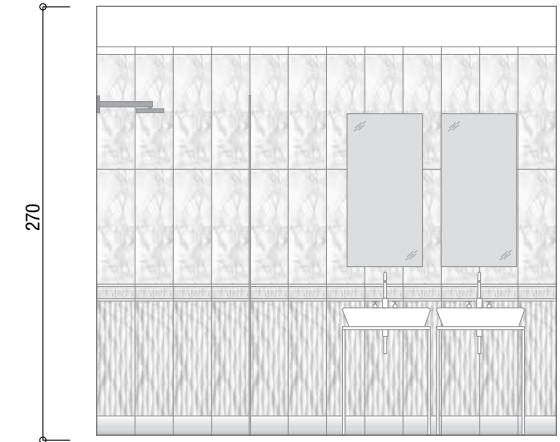

Wall B

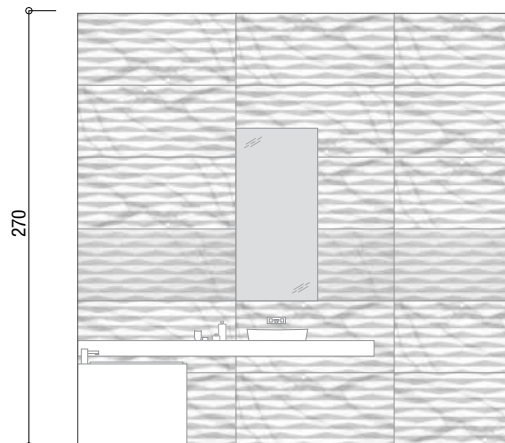

Wall C



Wall D

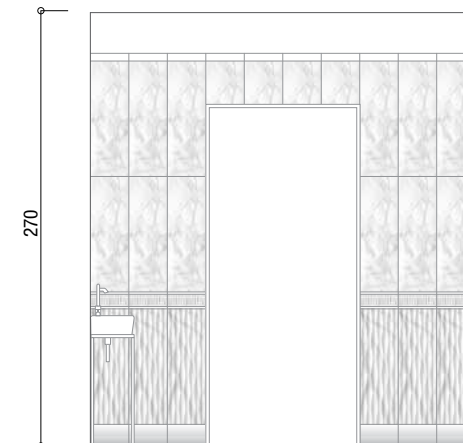

Wall C

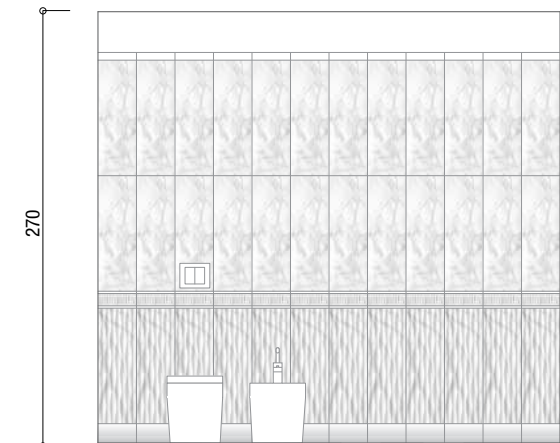

Wall D



Wall A-B-C-D
 Roma Calacatta 50x110 RT
 Roma Filo Calacatta 50x110 RT

Floor
 Bark Avana 25x150 RT

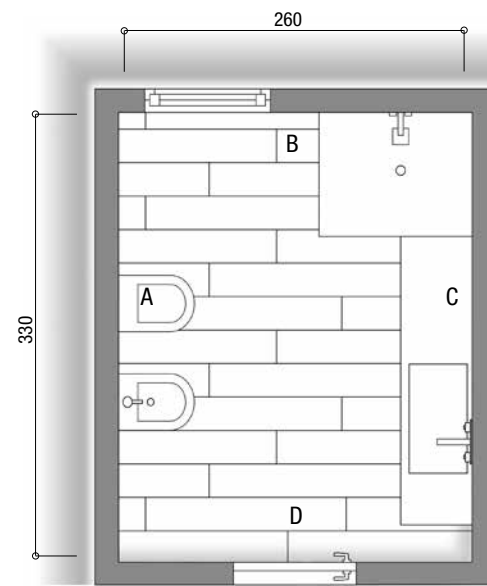

Wall A-B-C-D
 Roma Calacatta Alzata 17,5x25 RT
 Roma Calacatta A.I Alzata 2x11
 Roma Calacatta Raccordo 2x7,5 RT
 Roma Calacatta 7,5x30
 Roma Calacatta Matita 2x25 RT
 Roma Calacatta London 5,5x25 RT
 Roma Calacatta A.I London 1,5x5,5

Floor
 Roma Decò Calacatta Imperiale 20x20

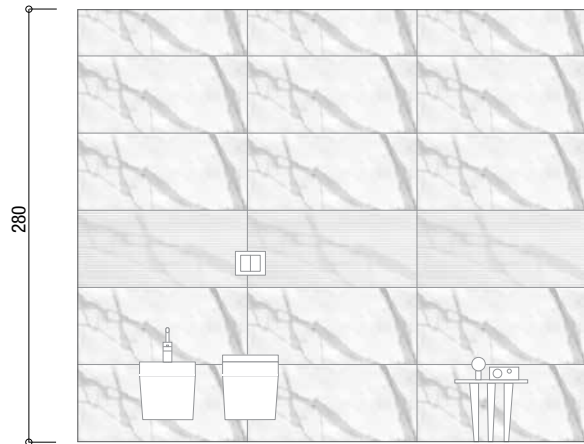
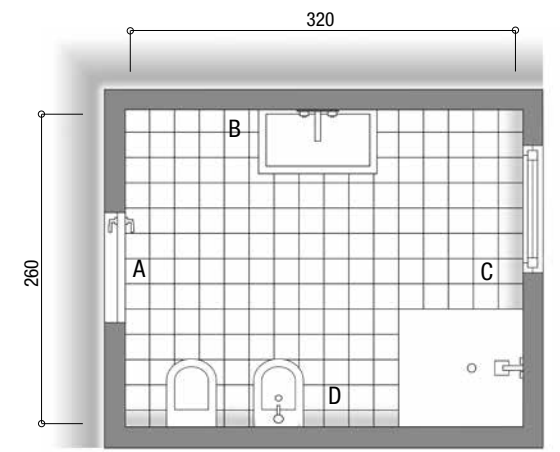

Wall A

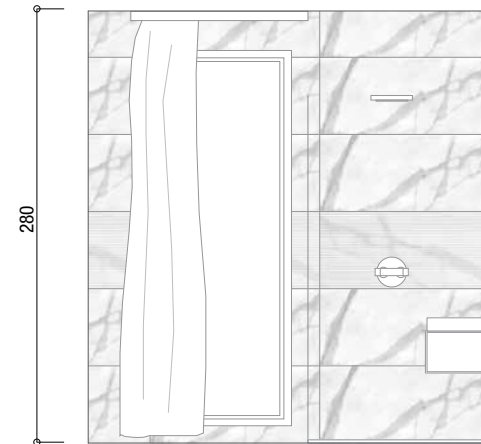

Wall B

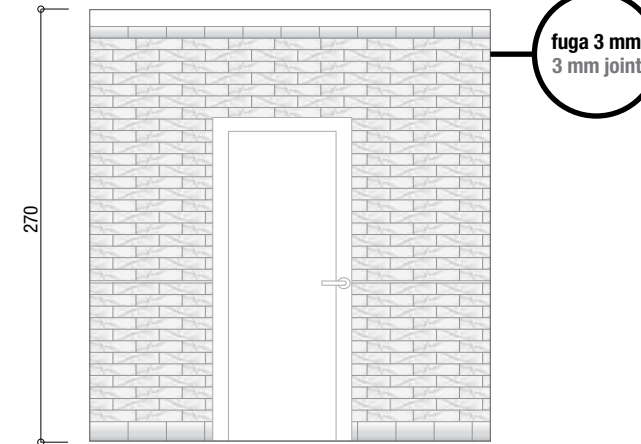

Wall A

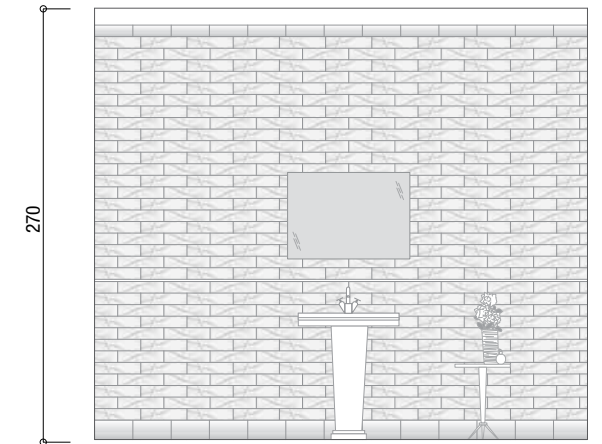

Wall B



Wall C



Wall D

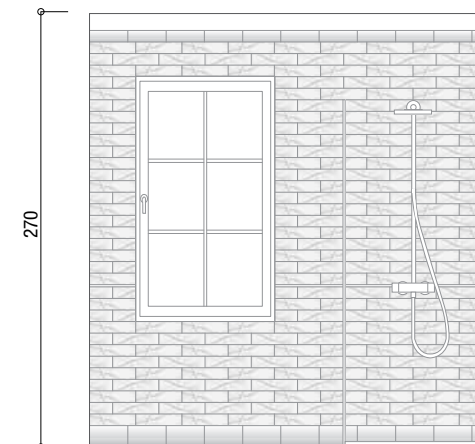

Wall C

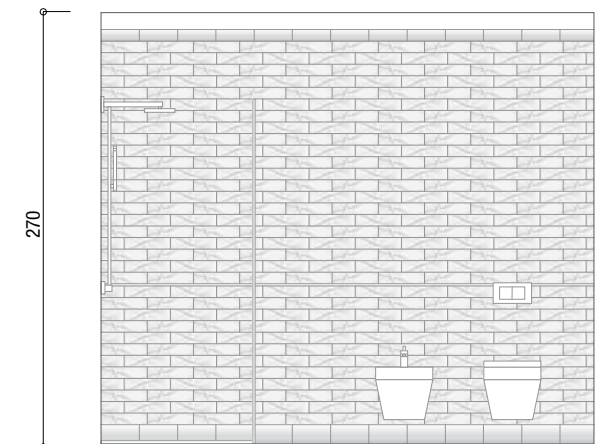

Wall D



Roma Statuario 50x110 RT

V3
1



Roma Calacatta 50x110 RT

V3
1



Roma Pietra 50x110 RT

V2
1



Roma Filo Statuario 50x110 RT

V3
2



Roma Filo Calacatta 50x110 RT

V3
2



Roma Filo Pietra 50x110 RT

V2
2



Roma Fold Statuario 50x110 RT

V3
3



Roma Fold Calacatta 50x110 RT

V3
3



Roma Imperiale 50x110 RT

V2
1



Roma Travertino 50x110 RT

V2
1

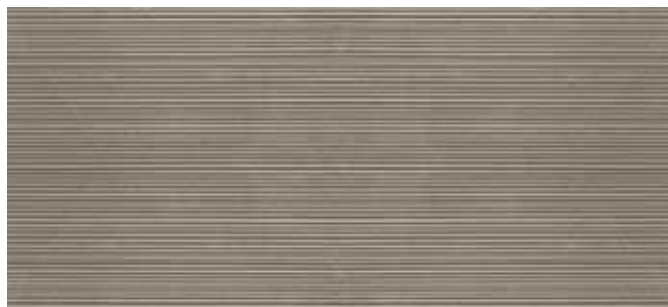

Roma Filo Imperiale 50x110 RT

V2
2



Roma Filo Travertino 50x110 RT

V2
2

	Unità di vendita Sales unit	MQ./Box	PZ./Box	Kg/Box	Box/PL
1	1 Box	1,65	3	28,90	36
2	1 Box	1,65	3	25,20	32
3	1 Box	1,65	3	29,30	32



Roma Statuario 25x75 V3 1



Roma Filo Statuario 25x75 V3 2



Roma Fold Statuario 25x75 V3 2



Roma Imperiale 25x75 V2 1



Roma Filo Imperiale 25x75 V2 2



Roma Pietra 25x75 V2 1



Roma Filo Pietra 25x75 V2 2



Roma Statuario London 5,5x25 3

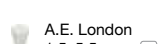

A.E. London 1,5x5,5 4

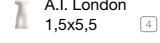

A.I. London 1,5x5,5 4

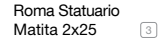

Roma Statuario Matita 2x25 3

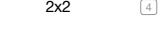

A.E. Matita 2x2 4

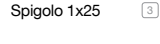

Roma Statuario Spigolo 1x25 3

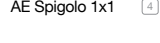

Roma Statuario AE Spigolo 1x1 4



Roma Imperiale Spigolo 1x25 3

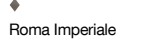

Roma Imperiale AE Spigolo 1x1 4



Roma Calacatta 25x75 V3 1



Roma Filo Calacatta 25x75 V3 2



Roma Fold Calacatta 25x75 V3 2



Roma Travertino 25x75 V2 1



Roma Filo Travertino 25x75 V2 2



Roma Calacatta London 5,5x25 3

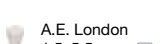

A.E. London 1,5x5,5 4

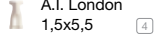

A.I. London 1,5x5,5 4

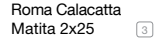

Roma Calacatta Matita 2x25 3

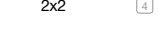

A.E. Matita 2x2 4

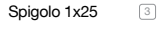

Roma Calacatta Spigolo 1x25 3

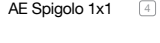

Roma Calacatta AE Spigolo 1x1 4



Roma Travertino Spigolo 1x25 3



Roma Travertino AE Spigolo 1x1 4

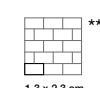
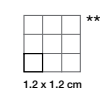
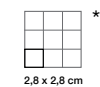
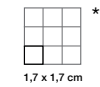

MOSAICO PASTA BIANCA
Spessore 8,5 mm - Thickness 8,5 mm



Roma Statuario Mosaico 30,5x30,5* 5



Roma Calacatta Mosaico 30,5x30,5* 5

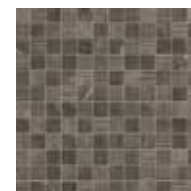

Roma Imperiale Mosaico 30,5x30,5* 5



Roma Travertino Mosaico 30,5x30,5* 5



Roma Pietra Mosaico 30,5x30,5* 5

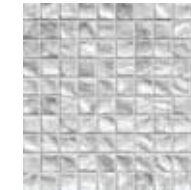

Roma Natura Statuario Mosaico 30,5x30,5** 6



Roma Natura Calacatta Mosaico 30,5x30,5** 6

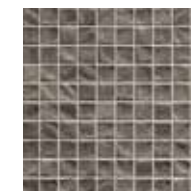

Roma Natura Imperiale Mosaico 30,5x30,5** 6

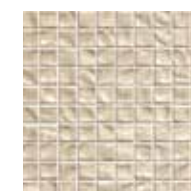

Roma Natura Travertino Mosaico 30,5x30,5** 6



Roma Natura Pietra Mosaico 30,5x30,5** 6

MOSAICO GRES PORCELLANATO
Spessore 10 mm - Thickness 10 mm



Roma Statuario Micromosaico 30x30*** 7



Roma Calacatta Micromosaico 30x30*** 7



Roma Imperiale Micromosaico 30x30*** 7



Roma Travertino Micromosaico 30x30*** 7



Roma Pietra Micromosaico 30x30*** 7



Roma Brick Statuario Mosaico 30x30**** 7



Roma Brick Calacatta Mosaico 30x30**** 7



Roma Brick Imperiale Mosaico 30x30**** 7



Roma Brick Travertino Mosaico 30x30**** 7



Roma Brick Pietra Mosaico 30x30**** 7

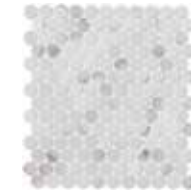

Roma Round Statuario Mosaico 29,5x32,5***** 8



Roma Round Calacatta Mosaico 29,5x32,5***** 8



Roma Round Imperiale Mosaico 29,5x32,5***** 8



Roma Round Travertino Mosaico 29,5x32,5***** 8



Roma Round Pietra Mosaico 29,5x32,5***** 8



Roma Grafite Micromosaico 30x30*** 7



Roma Brick Grafite Mosaico 30x30**** 7

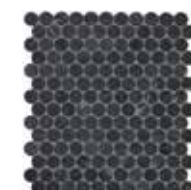

Roma Round Grafite Mosaico 29,5x32,5***** 8

	Unità di vendita Sales unit	MQ./Box	PZ./Box	Kg/Box	Box/PL
1	1 Box	1,125	6	16,80	54
2	1 Box	0,937	5	14,25	54
3	1 Box	-	5	-	-
4	1 Box	-	4	-	-
5	1 Box	0,558	6	8,20	84
6	1 Box	0,558	6	8,20	60
7	1 Box	0,54	6	10,20	60
8	1 Box	0,575	6	9,90	72



Roma Classic Statuario Inserto 50x110 RT

1



Roma Classic Statuario
List. 8x25

3

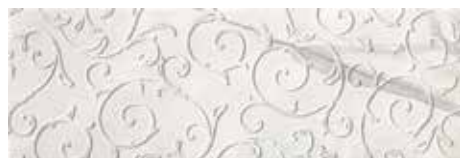

Roma Classic Statuario Inserto 25x75

2



Roma Classic Calacatta
List. 8x25

3



Roma Classic Calacatta Inserto 25x75

2



Roma Classic Pietra
List. 8x25

3



Roma Classic Pietra Inserto 25x75

2



Roma Greca
Statuario List. 8x25

3



Roma Fold Glitter Statuario Inserto 25x75

2



Roma Greca
Calacatta List. 8x25

3



Roma Greca
Pietra List. 8x25

3



Roma Fold Glitter Calacatta Inserto 25x75

2



Roma Statuario
Raccordo 2x25

3



Roma Calacatta
Raccordo 2x25

3



Roma Statuario
Alzata 17,5x25

3



Roma Calacatta
Alzata 17,5x25

3



Roma Statuario
A.E. Alzata 2x17,5

4



Roma Calacatta
A.E. Alzata 2x17,5

4



Roma Statuario
A.I. Alzata 2x17,5

4



Roma Calacatta
A.I. Alzata 2x17,5

4



Roma Raku
Listello 6x25

3

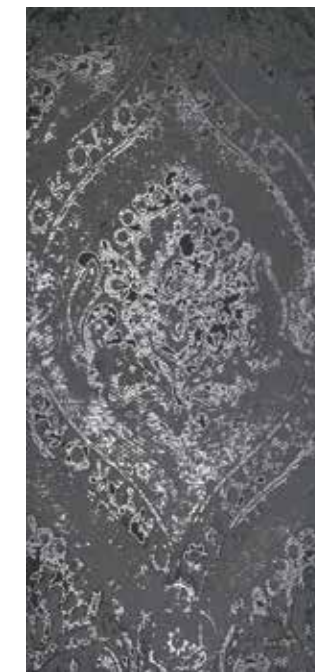

Roma Dark Inserto 50x110 RT

1

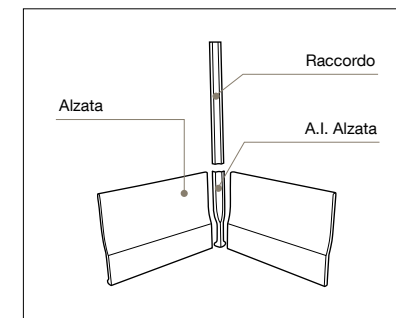

	Unità di vendita Sales unit	MQ./Box	PZ./Box	Kg/Box	Box/PL
1	1 Box	-	1	8,40	-
2	1 Box	-	4	12,10	-
3	1 Box	-	5	1,65	-

1



Roma Statuario V3



Roma Calacatta V3



Roma Imperiale V2



Roma Grafite V2

MATT

7,5x30

1

MATT

7,5x30

1

MATT

7,5x30

1

MATT

7,5x30

1



Roma Statuario 20x20 V3



Roma Calacatta 20x20 V3

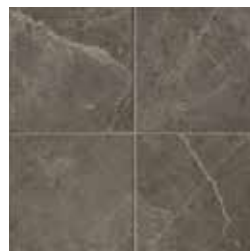

Roma Imperiale 20x20 V2



Roma Grafite 20x20 V2

MATT

20x20

2

MATT

20x20

2

MATT

20x20

2

MATT

20x20

2



Roma Decò 20
Statuario Grafite 20x20



Roma Decò 20
Calacatta Imperiale 20x20 V3

MATT

20x20

2

MATT

20x20

2

	Unità di vendita Sales unit	MQ./Box	PZ./Box	Kg/Box	Box/PL
1	1 Box	1,08	48	19,50	48
2	1 Box	1,20	30	23,90	56
3	1 Box	-	5	-	-
4	1 Box	-	4	-	-
5	1 Box	0,24	2 Mix	4,80	90
6	1 Box	2,25	6	4,80	90
7	1 Box	-	6	-	-



Roma Statuario
London 5,5x30 3

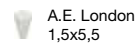

A.E. London
1,5x5,5 4

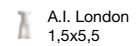

A.I. London
1,5x5,5 4

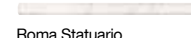

Roma Statuario
Matita 2x30 RT 3

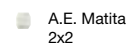

A.E. Matita
2x2 4



Roma Statuario
Spigolo 1x20 3



Roma Statuario
Spigolo 1x7,5 3



Roma Statuario
AE Spigolo 1x1 4



Roma Calacatta
London 5,5x30 3

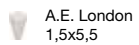

A.E. London
1,5x5,5 4

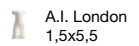

A.I. London
1,5x5,5 4

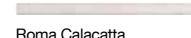

Roma Calacatta
Matita 2x30 RT 3

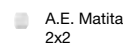

A.E. Matita
2x2 4

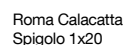

Roma Calacatta
Spigolo 1x20 3



Roma Calacatta
Spigolo 1x7,5 3



Roma Calacatta
AE Spigolo 1x1 4



Roma Imperiale
Spigolo 1x20 3

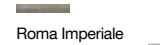

Roma Imperiale
Spigolo 1x7,5 3



Roma Imperiale
AE Spigolo 1x1 4

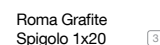

Roma Grafite
Spigolo 1x20 3



Roma Grafite
Spigolo 1x7,5 3



Roma Grafite
AE Spigolo 1x1 4



Roma Tracce Statuario Inserto Mix 3 20x60 5

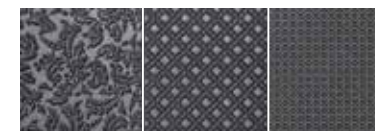

Roma Tracce Grafite Inserto Mix 3 20x60 5



Roma Tozzetto
Grafite 5x5 7



Roma Tozzetto
Statuario 5x5 7

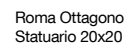

Roma Ottagono
Statuario 20x20 6

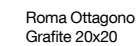

Roma Ottagono
Grafite 20x20 6

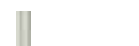

Roma Statuario
Raccordo 2x7,5 3



Roma Statuario
Alzata 17,5x30 3



Roma Statuario
A.E. Alzata 2x17,5 4



Roma Statuario
A.I. Alzata 2x17,5 4



Roma Calacatta
Raccordo 2x7,5 3



Roma Calacatta
Alzata 17,5x30 3



Roma Calacatta
A.E. Alzata 2x17,5 4



Roma Calacatta
A.I. Alzata 2x17,5 4

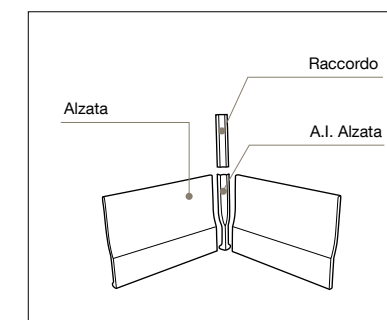



Roma Statuario 25x21,6 V3



Roma Calacatta 25x21,6 V3



Roma Imperiale 25x21,6 V2



Roma Grafite 25x21,6 V2

MATT



MATT



MATT



MATT

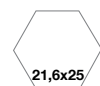

Roma Decò Esagono Statuario Grafite 25x21,6



Roma Decò Esagono Calacatta Imperiale 25x21,6

MATT

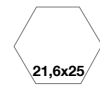

MATT

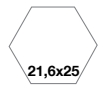

	Unità di vendita Sales unit	MQ./Box	PZ./Box	Kg/Box	Box/PL
1	1 Box	1,18	48	23,20	36



Roma Statuario Lux V3
LUX



Roma Grafite Lux V2
LUX



Roma Calacatta Lux V3
LUX



Roma Pietra Lux V2
LUX



Roma Imperiale Lux V2
LUX



Roma Travertino Lux V2
LUX

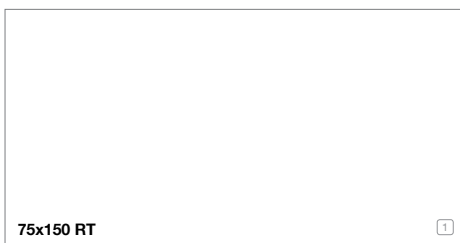

75x150 RT 1

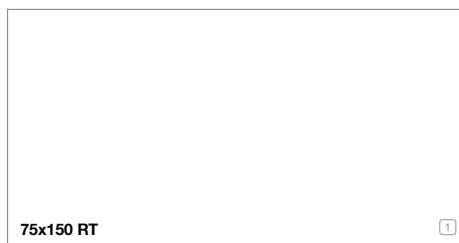

75x150 RT 1

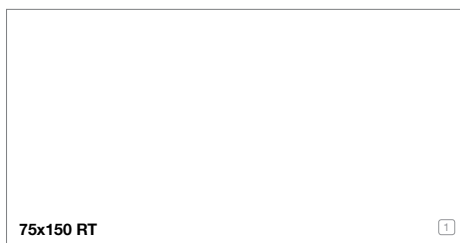

75x150 RT 1

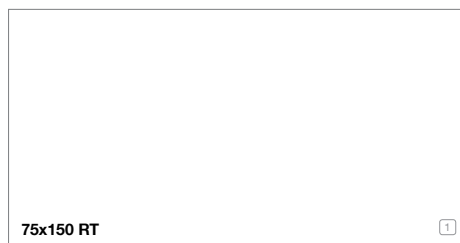

75x150 RT 1

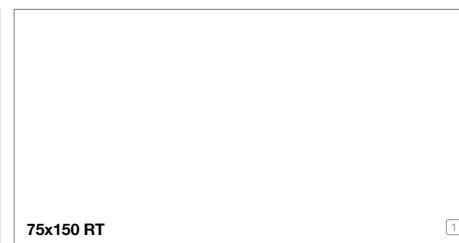

75x150 RT 1

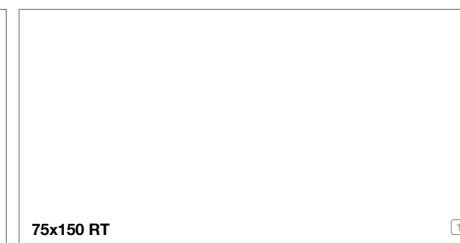

75x150 RT 1

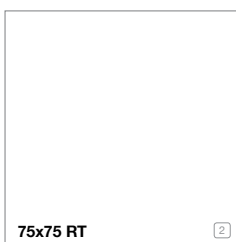

75x75 RT 2

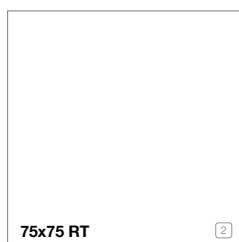

75x75 RT 2



75x75 RT 2

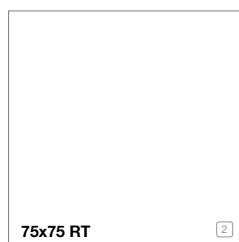

75x75 RT 2



75x75 RT 2



75x75 RT 2



60x60 RT 3



60x60 RT 3



60x60 RT 3



60x60 RT 3



60x60 RT 3



60x60 RT 3



30x60 RT 4



30x60 RT 4



30x60 RT 4



30x60 RT 4



30x60 RT 4



30x60 RT 4

	Unità di vendita Sales unit	MQ./Box	PZ./Box	Kg/Box	Box/PL
1	1 Box	1,125	1	26,50	25
2	1 Box	1,125	2	25,95	42
3	1 Box	1,080	3	24,82	40
4	1 Box	1,080	6	23,10	40



Roma Statuario Matt V3
MATT _____ **R 9**



Roma Grafite Matt V2
MATT _____ **R 9**



Roma Calacatta Matt V3
MATT _____ **R 9**



Roma Pietra Matt V2
MATT _____ **R 9**



Roma Imperiale Matt V2
MATT _____ **R 9**



Roma Travertino Matt V2
MATT _____ **R 9**

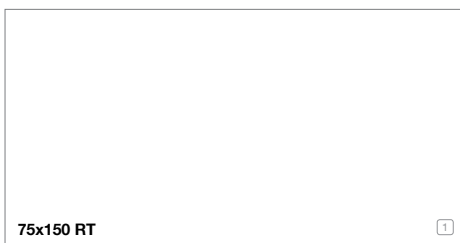

75x150 RT

1

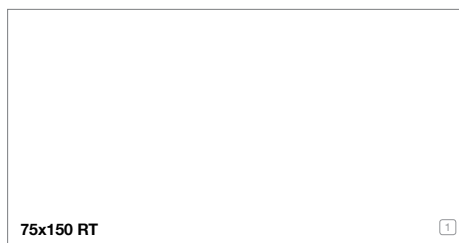

75x150 RT

1

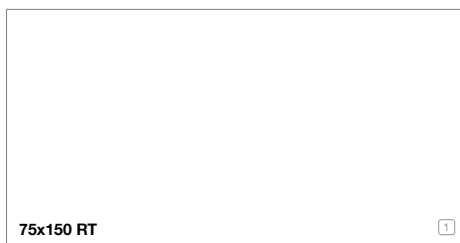

75x150 RT

1

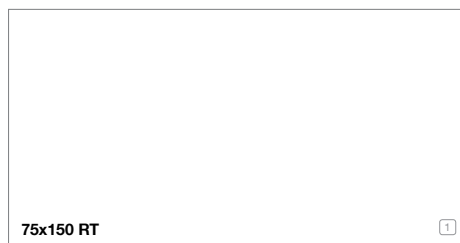

75x150 RT

1

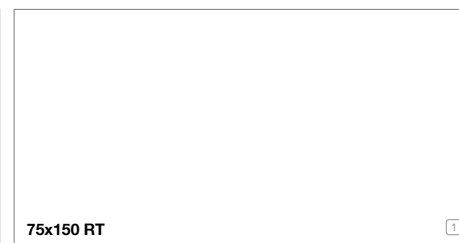

75x150 RT

1

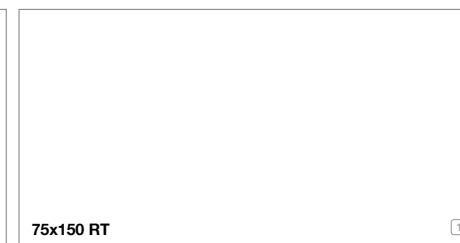

75x150 RT

1



75x75 RT

2



75x75 RT

2



75x75 RT

2



75x75 RT

2



75x75 RT

2



75x75 RT

2



60x60 RT

3



60x60 RT

3



60x60 RT

3



60x60 RT

3



60x60 RT

3



60x60 RT

3



30x60 RT

4



30x60 RT

4



30x60 RT

4



30x60 RT

4



30x60 RT

4



30x60 RT

4

	Unità di vendita Sales unit	MQ./Box	PZ./Box	Kg/Box	Box/PL
1	1 Box	1,125	1	26,50	25
2	1 Box	1,125	2	25,95	42
3	1 Box	1,080	3	24,82	40
4	1 Box	1,080	6	23,10	40

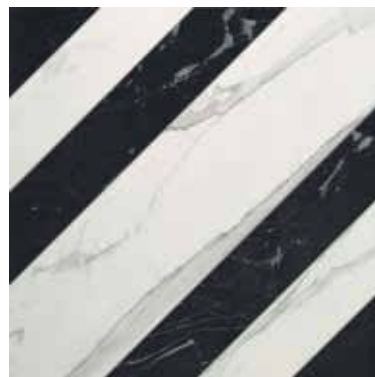

Roma Righe Statuario Grafite Matt Inserto
60x60 RT 1



Roma Righe Calacatta Imperiale Matt Inserto
60x60 RT 1



Roma Incroci Statuario Grafite Lux Inserto
60x60 RT 1



Roma Incroci Calacatta Avana Lux Inserto
60x60 RT 1

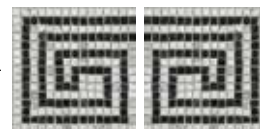

Roma Greca Statuario Grafite
Mosaico Mix 2 20x40 2

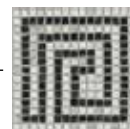

Roma Angolo Greca Statuario Grafite
Mosaico 20x20 2



MOSAICO



Roma Statuario
Macromosaico 30x30 3



Roma Statuario
Micromosaico 30x30* 3



Roma Brick Statuario
Mosaico 30x30** 3

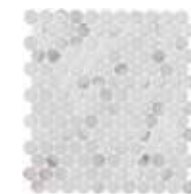

Roma Round Statuario
Mosaico 29,5x32,5*** 4



Roma Calacatta
Macromosaico 30x30 3



Roma Calacatta
Micromosaico 30x30* 3



Roma Brick Calacatta
Mosaico 30x30** 3



Roma Round Calacatta
Mosaico 29,5x32,5*** 4

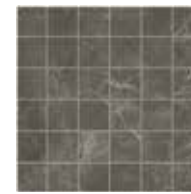

Roma Imperiale
Macromosaico 30x30 3

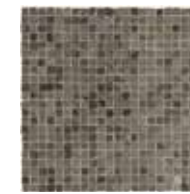

Roma Imperiale
Micromosaico 30x30* 3



Roma Brick Imperiale
Mosaico 30x30** 3



Roma Round Imperiale
Mosaico 29,5x32,5*** 4



Roma Travertino
Macromosaico 30x30 3



Roma Travertino
Micromosaico 30x30* 3



Roma Brick Travertino
Mosaico 30x30** 3

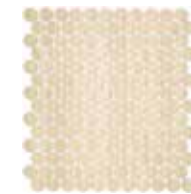

Roma Round Travertino
Mosaico 29,5x32,5*** 4



Roma Pietra
Macromosaico 30x30 3



Roma Pietra
Micromosaico 30x30* 3



Roma Brick Pietra
Mosaico 30x30** 3



Roma Round Pietra
Mosaico 29,5x32,5*** 4

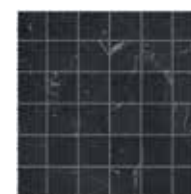

Roma Grafite
Macromosaico 30x30 3



Roma Grafite
Micromosaico 30x30* 3



Roma Brick Grafite
Mosaico 30x30** 3

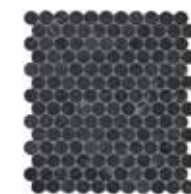

Roma Round Grafite
Mosaico 29,5x32,5*** 4

	Unità di vendita Sales unit	MQ./Box	PZ./Box	Kg/Box	Box/PL
1	1 Box	0,360	1	8,00	76
2	1 Box	0,160	4	3,20	180
3	1 Box	0,540	6	10,20	60
4	1 Box	0,575	6	9,90	72





Roma Avana Losanga 11x71 1



Roma Avana Losanga 11x131 2



Roma Nebbia Losanga 11x71 1



Roma Nebbia Losanga 11x131 2



Pezzi Speciali

Disponibili in tutti i colori. - Available in all colours. - Existent dans tous les coloris. - Erhältlich in allen Farben. Disponibles en todos los colores. - В продаже есть все цвета.

* Disponibile su ordinazione.
Available on demand.
Disponibile sur commande.
Erhältlich auf Bestellung.
Disponibile a pedido.
Изготовление на заказ.

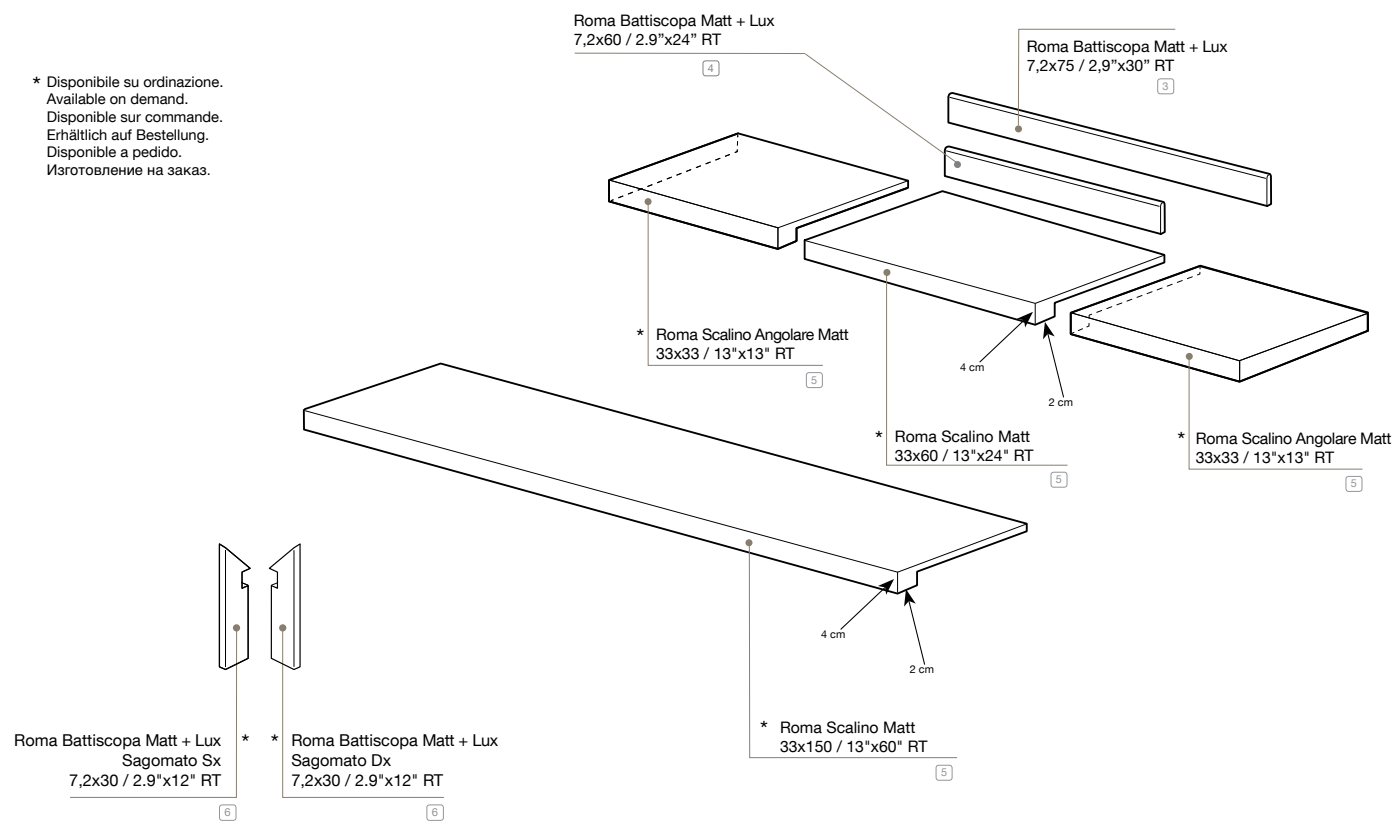

	Unità di vendita Sales unit	MQ./Box	PZ./Box	Kg/Box	Box/PL
1	1 Box	0,280	4	7,20	90
2	1 Box	0,740	4	13,36	60
3	1 Box	3,75 ML	5	6,02	140
4	1 Box	4,80 ML	8	6,02	72
5	1 Box	-	2	-	-
6	1 Box	2,40 ML	8	-	-

Suggerimenti di posa Installation tips - Conseils de pose - Empfehlungen und Verlegealternativen - Sugerencias de colocacion - Рекомендации по укладке

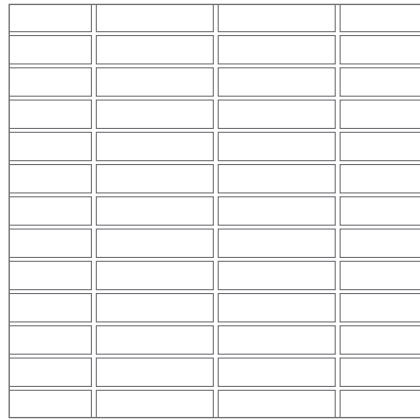

Roma 7,5x30

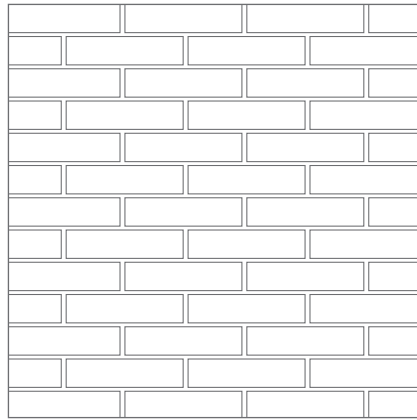

Roma 7,5x30

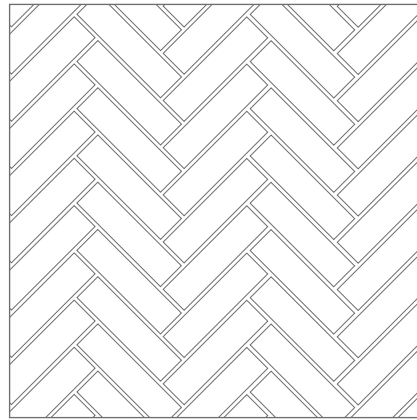

Roma 7,5x30

Fuga 3-5 mm / 3-5 mm gap / Joint 3-5 mm / Junta 3-5 mm / швом 3-5 mm

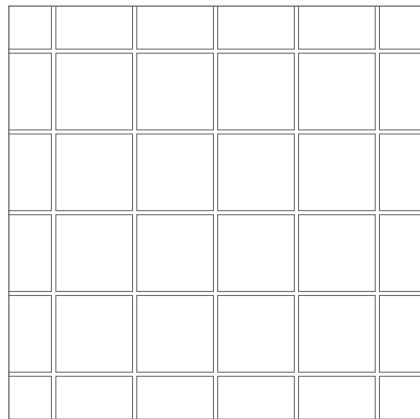

Roma 20x20

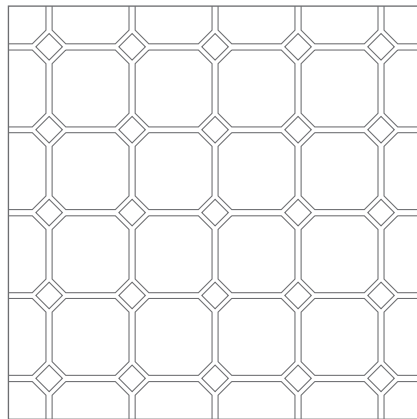

Roma Ottagono 20x20 - 93,75%
Roma Tozzetto 5x5 - 6,25%

Fuga 2-3 mm / 2-3 mm gap / Joint 2-3 mm / Junta 2-3 mm / швом 2-3 mm

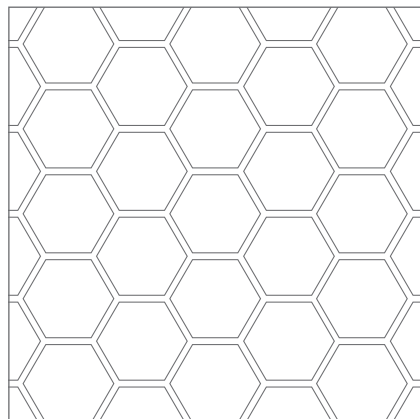

Roma Esagono

Fuga 2-3 mm / 2-3 mm gap / Joint 2-3 mm / Junta 2-3 mm / швом 2-3 mm

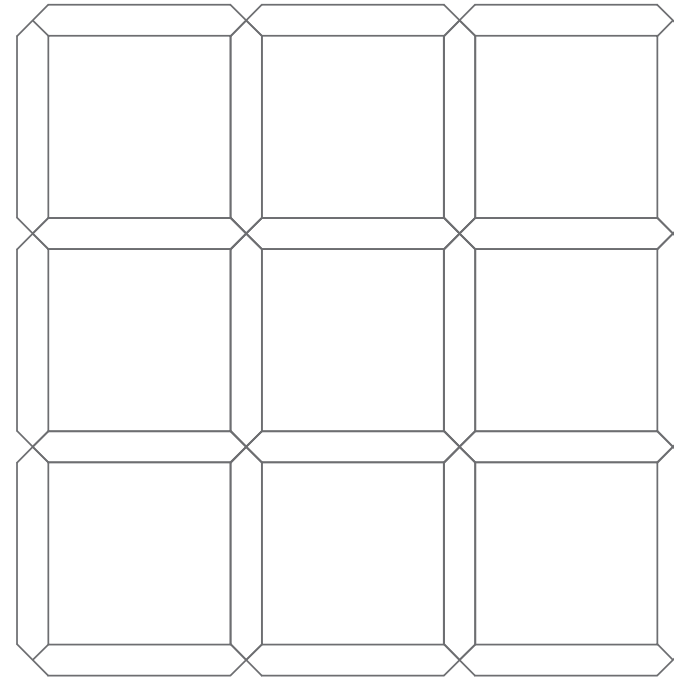

Roma 60x60 RT - 71,84%
Roma Losanga 11x71 RT - 28,16%

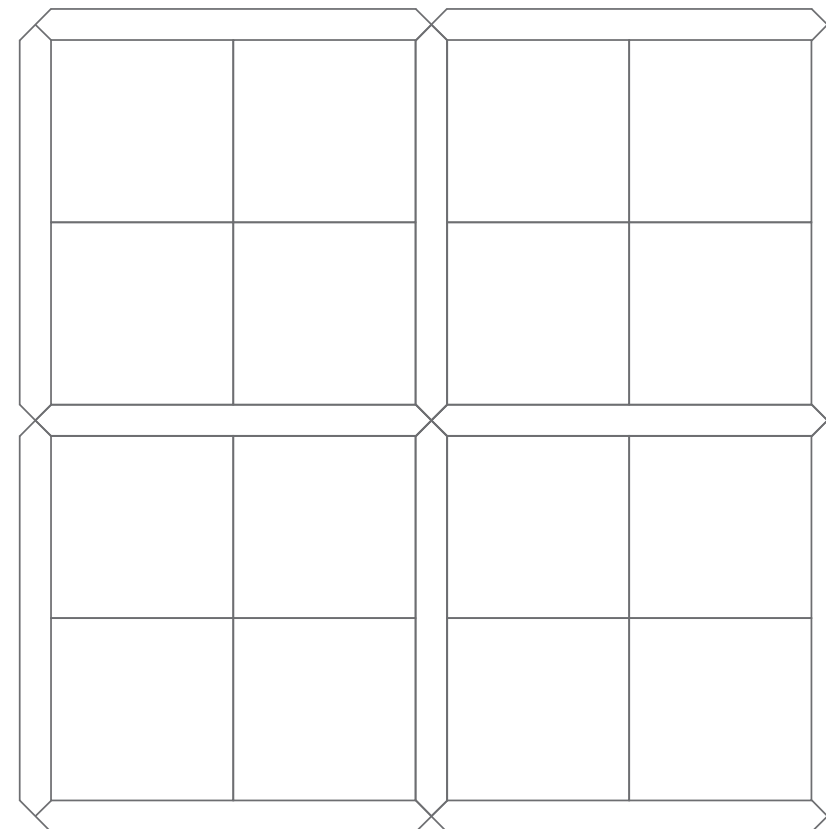

Roma 60x60 RT - 84,15%
Roma Losanga 11x131 RT - 15,85%

ROMA		STATUARIO	GRAFITE	CALACATTA	PIETRA	IMPERIALE	TRAVERTINO
PASTA BIANCA WHITE BODY	50x110 RT 20°x44°	MATT	-	MATT	MATT	MATT	MATT
	Filo 50x110 RT 20°x44°	MATT	-	MATT	MATT	MATT	MATT
	Fold 50x110 RT 20°x44°	MATT	-	MATT	-	-	-
	25x75 10°x30°	MATT	-	MATT	MATT	MATT	MATT
	Filo 25x75 10°x30°	MATT	-	MATT	MATT	MATT	MATT
	Fold 25x75 10°x30°	MATT	-	MATT	-	-	-
GRES PORCELLANATO PORCELAIN STONEWARE	75x150 RT 30°x60°	MATT R9 LUX	MATT R9 LUX	MATT R9 LUX	MATT R9 LUX	MATT R9 LUX	MATT R9 LUX
	75x75 RT 30°x30°	MATT R9 LUX	MATT R9 LUX	MATT R9 LUX	MATT R9 LUX	MATT R9 LUX	MATT R9 LUX
	60x60 RT 24°x24°	MATT R9 LUX	MATT R9 LUX	MATT R9 LUX	MATT R9 LUX	MATT R9 LUX	MATT R9 LUX
	30x60 RT 12°x24°	MATT R9 LUX	MATT R9 LUX	MATT R9 LUX	MATT R9 LUX	MATT R9 LUX	MATT R9 LUX
ATELIER	21,6x25,9 9°x10°	MATT	MATT	MATT	-	MATT	-
	20x20 8°x8°	MATT	MATT	MATT	-	MATT	-
	7,5x30 3°x12°	MATT	MATT	MATT	-	MATT	-
MOSAICI PASTA BIANCA WHITE BODY MOSAICS	Roma Mosaico 30,5x30,5 12°x12°	MATT	-	MATT	MATT	MATT	MATT
	Roma Natura Mosaico 30,5x30,5 12°x12°	MATT	-	MATT	MATT	MATT	MATT

ROMA		STATUARIO	GRAFITE	CALACATTA	PIETRA	IMPERIALE	TRAVERTINO
MOSAICI GRES PORCELLANATO PORCELAIN STONEWARE MOSAICS	Roma Macromosaico 30x30 12°x12°	MATT	MATT	MATT	MATT	MATT	MATT
	Roma Micromosaico 30x30 12°x12°	MATT	MATT	MATT	MATT	MATT	MATT
	Roma Brick Mosaico 30x30 12°x12°	MATT	MATT	MATT	MATT	MATT	MATT
	Roma Round Mosaico 29,5x32,5 12°x13°	MATT	MATT	MATT	MATT	MATT	MATT
PEZZI SPECIALI GRES PORCELLANATO PORCELAIN STONEWARE TRIMS	Battiscopa 7,2x75 RT 2,9°x30°	LUX MATT	LUX MATT	LUX MATT	LUX MATT	LUX MATT	LUX MATT
	Battiscopa 7,2x60 RT 2,9°x24°	LUX MATT	LUX MATT	LUX MATT	LUX MATT	LUX MATT	LUX MATT
	Scalino 33x150 RT 13°x60°	MATT	MATT	MATT	MATT	MATT	MATT
	Scalino 33x60 RT 13°x24°	MATT	MATT	MATT	MATT	MATT	MATT
	Scalino Angolare 33x33 RT 13°x13°	MATT	MATT	MATT	MATT	MATT	MATT

Informazioni utili

Useful information. / Informations utiles. / Nützliche Informationen. / Información útil. / Полезная информация.



FAP È MADE IN ITALY

Tutte le piastrelle Fap ceramiche sono prodotte in Italia. Chi acquista ceramiche Fap ha la sicurezza che esse siano prodotte con tecnologie che rispettano l'ambiente, utilizzando materie prime eccellenti e sicure, garantendo le migliori condizioni di lavoro possibile.



Fap ceramiche aderisce al Codice Etico di Confindustria Ceramica, che impegna le aziende a comunicare con chiarezza l'origine dei propri prodotti. Il marchio Ceramics of Italy può essere utilizzato esclusivamente per contrassegnare i prodotti ceramici realizzati in Italia.

FAP IS MADE IN ITALY

All Fap ceramiche tiles are produced in Italy. Anyone purchasing Fap ceramics can be sure that they are produced using technologies that respect the environment, using safe, excellent raw materials, guaranteeing the best possible working conditions.

Fap ceramiche follows the Confindustria Ceramica Code of Ethics, which commits businesses to clearly informing of the origin of their products. The Ceramics of Italy trade mark can be used exclusively on ceramic products made in Italy.

FAP EST MADE IN ITALY

Toute la production de carreaux Fap ceramique est réalisée en Italie. Acheter un produit Fap c'est avoir la certitude d'une technologie qui respecte l'environnement, de matières premières nobles et sûres et d'une attention particulière aux conditions de travail.

Fap ceramiche adhère au Code d'Ethique de Confindustria Ceramica qui impose aux entreprises de communiquer clairement l'origine de ses produits. Le label Ceramics of Italy ne peut être utilisé que pour des carreaux céramique intégralement fabriqués en Italie.

FAP IST IN ITALIEN HERGESTELLT

Alle Fliesen von Fap ceramiche werden in Italien erzeugt. Durch den Kauf von Keramikprodukten von Fap erhält man die Sicherheit, dass sie mit umweltfreundlichen Technologien unter Einsatz von ausgezeichneten, sicheren Rohstoffen produziert wurden, wobei die bestmöglichen Arbeitsbedingungen gewährleistet werden.

Fap ceramiche hält sich an den Ehrenkodex von Confindustria Ceramica, der die Firmen verpflichtet, den Ursprung der eigenen Produkte klar mitzuteilen. Das Markenzeichen Ceramics of Italy darf ausschließlich für die Kennzeichnung von in Italien erzeugten Keramikprodukten verwendet werden.

FAP - ЭТО MADE IN ITALY

Вся керамическая плитка от компании Fap ceramiche производится в Италии. Тот, кто выбирает плитку Fap, может быть уверен, что при её изготовлении применяются природосберегающие технологии и используется высококачественное и надежное сырьё при обеспечении наилучших условий труда

Компания Fap ceramiche присоединяется к Этическому Кодексу Confindustria Ceramica (Объединение предпринимателей керамической промышленности), согласно которому предприятия обязаны чётко указывать происхождение собственной продукции. Марка Ceramics of Italy может быть использована исключительно на товарах, произведенных в Италии.



FAP È ECO DESIGN

Ecolabel è il marchio di qualità ecologica della Comunità Europea, rilasciato esclusivamente ai prodotti con ridotto impatto ambientale. Ecolabel valuta l'intero ciclo di vita del prodotto: estrazione delle materie prime, processo produttivo, distribuzione, utilizzo e smaltimento. Tutti i prodotti Fap ceramiche rispettano i requisiti Ecolabel.

FAP IS ECO DESIGN

Ecolabel is the European Community green quality brand, issued exclusively to products with reduced environmental impact. Ecolabel assesses the whole product life cycle: extraction of raw materials, production process, distribution, use and disposal. All Fap ceramiche products comply with Ecolabel requirements.

FAP EST ÉCO-DESIGN

Ecolabel est le label écologique des pays de l'Union Européenne attribué aux produits dont l'impact sur l'environnement est limité. Ecolabel exige un impact réduit pendant tout le cycle de vie : extraction des matières premières, procédé de production, distribution, utilisation et élimination. Tous les produits Fap ceramiche respectent les critères Ecolabel.

FAP IST ÖKO-DESIGN

Ecolabel ist ein Umweltgütesiegel der Europäischen Union, das ausschließlich Produkten mit geringen Auswirkungen auf die Umwelt verliehen wird. Das Ecolabel beurteilt den gesamten Lebenszyklus des Produkts, von der Gewinnung der Rohstoffe über den Produktionsprozess, den Vertrieb und Einsatz bis hin zur Entsorgung. Alle Produkte von Fap ceramiche erfüllen die Anforderungen des Ecolabels.

FAP - ЭТО ЭКОДИЗАЙН

Марка Ecolabel применяется в Европейском Сообществе для обозначения экологически чистой продукции, при изготовлении которой было сокращено общее воздействие на окружающую среду. Ecolabel учитывает полный жизненный цикл изделия: добыча сырья, производственный процесс, сбыт, использование и обработка отходов. Вся продукция Fap ceramiche соответствует требованиям Ecolabel.



Lo standard LEED è un sistema di certificazione che indica i requisiti per costruire edifici ambientalmente sostenibili. La certificazione LEED, elaborata da U.S.Green Building Council e riconosciuta a livello internazionale, afferma che un edificio è rispettoso dell'ambiente e che costituisce un luogo salubre in cui vivere e lavorare. Il sistema si basa sull'attribuzione di punti legati ai requisiti di sostenibilità. L'utilizzo di piastrelle di ceramica può contribuire ad ottenere crediti LEED.

The LEED standard is a certification system indicating the requirements for the construction of environmentally sustainable buildings. The internationally acknowledged LEED certification, drawn up by the U.S.Green Building Council, states that a building respects the environment and is a healthy place to live and work in. The system is based on the allocation of points for a series of sustainability requirements. The use of ceramic tiles can help to obtain LEED credits.

Le LEED est un système de certification définissant des critères qui régissent la construction de bâtiments à haute qualité environnementale. Élaboré par l'U.S.Green Building Council et internationalement reconnu, le certification LEED est délivrée aux bâtiments respectueux de l'environnement et constituant un lieu salubre dans lequel vivre et travailler. L'obtention de la certification repose sur un système de points de crédit attribués selon des critères d'évaluation de la durabilité de la construction. L'utilisation de carreaux céramique peut contribuer à obtenir des points de crédit LEED.

Der LEED-Standard ist ein Zertifizierungssystem, das die Anforderungen für die Errichtung von umweltverträglichen Gebäuden vorgibt. Die vom U.S.Green Building Council erarbeitete und international anerkannte LEED-Zertifizierung erklärt, dass ein Gebäude umweltfreundlich ist und einen gesunden Arbeits- und Wohnraum darstellt. Das System beruht auf der Vergabe von Punkten auf Grundlage der Umweltverträglichkeitsanforderungen. Die Verwendung von Keramikfliesen kann zur Vergabe von LEED-Punkten beitragen.

Стандарт LEED – это система сертификации, включающая требования, предъявляемые к зелёному строительству. Получивший международное признание сертификат LEED был разработан организацией U.S.Green Building Council. Он свидетельствует о том, что здание было построено без нанесения вреда окружающей среде и является благоприятным местом для жизни и работы. Система основана на присуждении зачетных баллов в зависимости от степени соответствия требованиям экологически чистого строительства. Использование керамической плитки может способствовать получению баллов LEED.

L'UTILIZZO DI PIASTRELLE DI CERAMICA PUÒ CONTRIBUIRE AD OTTENERE I SEGUENTI CREDITI LEED:

Heat island effect SS 7.1 può contribuire ad ottenere 1 credito LEED. Ha lo scopo di limitare l'effetto isola di calore, per ridurre al minimo l'impatto sul microclima e l'habitat.

L'utilizzo dei colori Statuario, Calacatta, Pietra, Travertino della collezione Roma può contribuire ad ottenere 1 credito LEED.

Innovation in design ID 1.1-1.4 può contribuire ad ottenere da 1 a 4 crediti LEED.

Premia le performance che rappresentano risultati innovativi e migliorativi per il green building, ad esempio l'utilizzo di prodotti certificati Ecolabel. L'utilizzo delle piastrelle Fap (oltre il 90% sono certificate Ecolabel) può contribuire ad ottenere da 1 a 4 crediti LEED.

Emission of voc EQ 4.2 può contribuire ad ottenere 1 credito LEED. L'utilizzo di materiali che non emettono alcuna sostanza organica come le piastrelle Fap può contribuire ad ottenere 1 credito LEED.

Recycled content MR 4.1 può contribuire ad ottenere 1 credito LEED. Gli articoli in pasta bianca della collezione Roma contengono più del 20% di materiale riciclato pre-consumer e può contribuire ad ottenere 1 credito LEED.

THE USE OF CERAMIC TILES CAN HELP TO OBTAIN THE FOLLOWING LEED CREDITS:

Heat island effect SS 7.1 can help to obtain 1 LEED credit. It aims to limit the heat island effect in order to reduce impact on micro-climates and habitats to a minimum.

Using the colours Statuario, Calacatta, Pietra, Travertino in the Roma collection can help you qualify for 1 LEED credit.

Innovation in design ID 1.1-1.4 can help to obtain between 1 and 4 LEED credits.

Rewarding performances that represent innovative results that help to improve green building, for example the use of Ecolabel certified products. The use of Fap tiles (more than 90% are Ecolabel certified) can help to obtain between 1 and 4 LEED credits.

Emission of voc EQ 4.2 can help to obtain 1 LEED credit. The use of materials with low emissions of volatile organic substances like Fap tiles can help to obtain 1 LEED credit.

Recycled content MR 4.1 can help to obtain 1 LEED credit. The white body items in the Roma collection contain more than 20% of pre-consumer recycled material and can help you qualify for 1 LEED credit.

L'UTILISATION DE CARREAUX CÉRAMIQUE PEUT CONTRIBUER À L'OBTENTION DES CRÉDITS LEED SUIVANTS :

Heat island effect SS 7.1, a le but de limiter l'effet îlot de chaleur afin ne pas affecter le microclimat et l'habitat environnant et peut contribuer à l'obtention d'1 point de crédit LEED.

L'utilisation des couleurs Statuario, Calacatta, Pietra, Travertino de la collection Roma peut contribuer à l'obtention d'1 point de crédit LEED.

Innovation in design ID 1.1-1.4, peut contribuer à l'obtention d'1 à 4 points de crédit LEED ; elle récompense les initiatives représentant des actions innovantes et susceptibles d'améliorer l'éco-construction, comme la mise en oeuvre de produits certifiés Ecolabel. L'utilisation des carreaux Fap (dont plus de 90 % sont certifiés Ecolabel) peut contribuer à l'obtention de 1 à 4 points de crédit LEED.

Emission of voc EQ 4.2 peut contribuer à obtenir 1 point de crédit LEED. L'utilisation de matériaux contenant un faible taux de COV (composés organiques volatiles) comme les carreaux Fap peut contribuer à l'obtention d'1 point de crédit LEED.

Recycled content MR 4.1 peut contribuer à l'obtention d'1 point de crédit LEED.

Les articles de la collection Roma possédant un support en pâte blanche contiennent plus de 20 % de matériau recyclé (produit semi-fini récupéré durant la fabrication) ce qui peut permettre l'obtention d'1 point de crédit LEED.

DURCH DIE VERWENDUNG VON KERAMIKFLIESEN KÖNNEN FOLGENDE LEED-PUNKTE ERZIELT WERDEN:

Heat island effect SS 7.1 kann zur Vergabe von 1 LEED-Punkt beitragen. Sein Zweck ist, den Wärmeiselleffekt einzuschränken und die Auswirkung auf das Mikroklima und den Lebensraum zu senken. Die Verwendung der Farben Statuario, Calacatta, Pietra, Travertino der Kollektion Roma kann dazu beitragen, einen LEED-Credit zu erhalten.

Innovation in design ID 1.1-1.4 kann zur Vergabe von 1 bis 4 LEED-Punkten beitragen. Belohnt die Leistungen, die innovative Ergebnisse und Verbesserungen für das „Green Building“ darstellen, wie zum Beispiel die Verwendung von Produkten, die mit dem Ecolabel ausgezeichnet wurden. Die Verwendung von Fap-Fliesen (mehr als 90% sind mit dem Ecolabel bescheinigt) kann zur Vergabe von 1 bis 4 LEED-Punkten beitragen.

Emission of voc EQ 4.2 kann zur Vergabe von 1 LEED-Punkt beitragen. Die Verwendung von Materialien mit niedrigen VOC-Emissionen (flüchtige organische Verbindungen) wie den Fliesen von Fap kann zur Vergabe von 1 LEED-Punkt beitragen.

Recycled content MR 4.1 kann zur Vergabe von 1 LEED-Punkt beitragen. Die Fliesen aus weißem Scherben der Kollektion Roma enthalten mehr als 20% pre-consumer recyceltes Material und können dazu beitragen, einen LEED-Credit zu erhalten.



Posa, stuccatura e pulizia

Pasta bianca

PREMESSA IMPORTANTE: PER POSA E STUCCATURA RIVOLGERSI A POSATORI PROFESSIONISTI.

Posa
Una corretta posa in opera, seguendo alcune semplici regole, garantirà un perfetto risultato finale:

- 1) controllare la planarità delle pareti da rivestire;
- 2) posare il prodotto miscelando il materiale prelevato da più scatole;
- 3) maneggiare con cura il prodotto prima e durante la posa;
- 4) Fap ceramiche consiglia di utilizzare esclusivamente adesivi di classe C2 secondo la normativa europea EN 12004. Utilizzare collanti bianchi per rivestimenti ceramici antiscivolamento. Per un risultato ottimale aggiungere un elasticizzante avendo cura di seguire scrupolosamente le indicazioni del produttore, occorre applicare uno strato omogeneo del collante sul sottofondo. Lo spessore del collante può essere regolato utilizzando il lato dentato del frattazzo.

IMPORTANTE:
I rivestimenti rettificati di Fap sono stati progettati e realizzati per consentire la posa accostata (senza fuga) delle piastrelle. Ciò consente di ottenere il miglior risultato estetico (pareti unite) e funzionale (non trattiene lo sporco perché non ci sono fughe).

Stuccatura
Utilizzare stucchi in tinta.

Pulizia
Utilizzare strumenti per la pulizia perfettamente puliti. Sciacquare sempre le superfici. Per lavaggi frequenti utilizzare semplicemente acqua pulita.

Gres porcellanato

PREMESSA IMPORTANTE: PER POSA E STUCCATURA RIVOLGERSI A POSATORI PROFESSIONISTI.

Posa
Una corretta posa in opera, seguendo alcune semplici regole, garantirà un perfetto risultato finale:

- 1) controllare la planarità del massetto su cui posare le piastrelle da pavimento;
- 2) posare il prodotto miscelando il materiale prelevato da più scatole;
- 3) maneggiare con cura il prodotto prima e durante la posa;

IMPORTANTE:
I pavimenti rettificati di Fap devono essere posati con una fuga di 2-3 mm. Per la posa in esterno si consiglia una fuga di 3 mm. Per pavimenti posati a correre, sfasatura massima di 1/3 fra le doghe. Gli esagoni devono essere posati con una fuga da 3 a 5 mm.

Stuccatura
Utilizzare stucchi in tinta.

Pulizia
Le regole per la pulizia a cura del posatore devono essere applicate quando vengono utilizzati stucchi cementizi. Quando si usano stucchi epossidici, ci si deve attenere alle indicazioni dei produttori.

Pulizia a cura del posatore.

1 Prima pulizia: quando, dopo 10-20 minuti dalla stuccatura lo stucco perde plasticità e diventa opaco si proceda alla rimozione dell'eccesso di sigillante con una spugna umida e pulita. Si deve poi effettuare una pulizia a secco con un panno asciutto o con un feltro.

2 Pulizia finale: dopo 36/48 ore sia piastrelle che fughe hanno completato la loro stagionatura, si deve procedere al lavaggio della superficie con un acido ad azione tamponata. Si deve poi risciacquare con abbondante acqua pulita, da rimuovere con una aspira-liquidi.

IMPORTANTISSIMO: è fondamentale che la pulizia a cura del posatore sia effettuata a regola d'arte affinché il pavimento risulti di facile manutenzione. La cura con la quale si eseguono la prima pulizia e la pulizia finale (in particolare l'asportazione totale degli stucchi residui) influenzeranno la pulibilità del pavimento. Tale procedura è prevista dai migliori produttori di stuccature per fughe e collanti, per tutti i pavimenti in gres porcellanato. Non rispettare queste raccomandazioni, o utilizzare acqua non perfettamente pulita, può determinare il fissaggio di una patina di stucco o di polvere di cantiere estremamente assorbente, non perfettamente visibile ad occhio nudo, che cattura la polvere esistente nell'ambiente e può rendere il pavimento perennemente sporco. In questo caso Fap ceramiche declina ogni responsabilità.

Pulizia ordinaria.

3 Frequenza: come d'abitudine.
Avvertenze:

a] utilizzare strumenti per la pulizia perfettamente puliti; **b]** sciacquare sempre il pavimento; **c]** non calpestare il pavimento bagnato; **d]** per lavaggi frequenti può essere utilizzata semplicemente acqua pulita o prodotti detergenti specifici per rimuovere sporco e macchie purché non siano ceranti, filmanti o pellicolanti. Sconsigliamo l'utilizzo di prodotti con l'indicazione "non occorre il risciacquo".

Pulizia a cura del posatore.

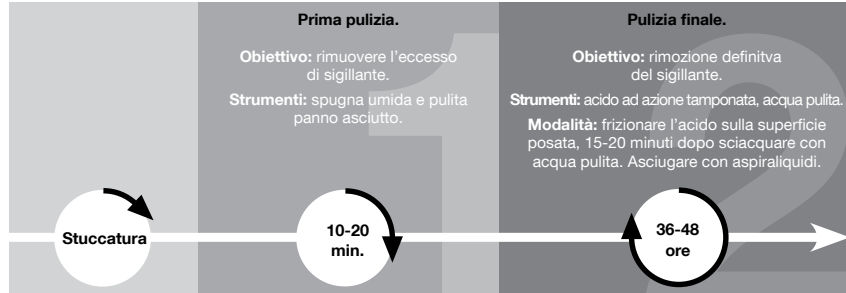

Pulizia ordinaria a cura dell'utilizzatore.

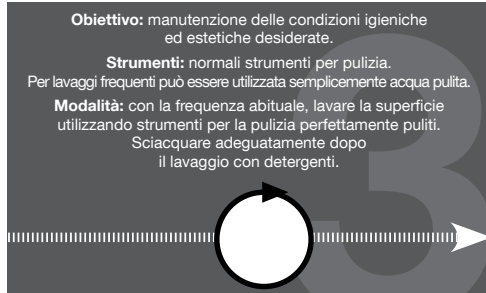

Gres Porcellanato Brillante

Il gres porcellanato Brillante è realizzato attraverso una speciale processo di lucidatura che esalta la morbida struttura della superficie delle piastrelle. Si ottiene così un sofisticato effetto di vibranti riflessi che regalano unicità al pavimento. Il processo di lucidatura di tutti i prodotti levigati e lappati presenti sul mercato, avviene attraverso l'asportazione di una piccola parte di materiale e la possibile apertura di alcuni micropori in superficie, rendendo il prodotto più attaccabile alle macchie. Si consiglia l'utilizzo di stucchi in cadenza di colore con la piastrella per ridurre il contrasto. Durante la posa non si devono segnare i materiali sulla superficie di utilizzo con matite o pennarelli indelebili.

Advice on laying, grouting and maintenance

White body

IMPORTANT NOTE: TILES SHOULD BE LAID AND GROUTED ONLY BY PROFESSIONAL TILE LAYERS.

Tiling
Follow the simple rules below to guarantee perfect tiling results:

- 1) Check the walls that are going to be tiled are flat;
- 2) Mix the tiles during tiling by taking them from several boxes
- 3) Handle the tiles with care before and during tiling.
- 4) For installing its wall tiles, Fap ceramiche recommends the use of class C2 adhesives, in compliance with the European standard EN 12004. Specifically recommended is a white glue for non-slip ceramic covering materials. For top-class results, add an elasticator, taking care to follow the manufacturer's instructions to the letter, and apply an even layer of glue on the underside of the tile. The thickness of the glue can be adjusted using the toothed side of the trowel.

IMPORTANT:
Fap's rectified wall tiles are designed and manufactured so that joint free (seamless) tiling is possible. This gives the best final appearance (seamless walls) and performance (the tiles do not collect dirt because there are no gaps).

Grouting
Use matching grouts.

Cleaning
Use cleaning tools that are perfectly clean themselves. Always rinse off surfaces. Use clean water alone if the surface is washed frequently.

Porcelain stoneware

IMPORTANT NOTE: TILES SHOULD BE LAID AND GROUTED ONLY BY PROFESSIONAL TILE LAYERS.

Tiling
Follow the simple rules below to guarantee perfect tiling results:

- 1) Check the floor slab is flat where the tiles are to be fitted;
- 2) Mix the tiles during tiling by taking them from several boxes
- 3) Handle the tiles with care before and during tiling.

IMPORTANT:
Fap rectified floor tiles must be laid with a 2-3 mm gap between them. For the laying outdoors we recommend a gap of 3 mm. For floors with a lengthwise tiling layout, maximum 1/3 offset between panels. The hexagons will have to be laid with a 3 to 5 mm gap between tiles.

Grouting
Use matching grouts.

Cleaning
When cement-based grouts are used, the tiler should follow the instructions for cleaning. Follow the manufacturer's instructions if epoxy grouts are used.

Cleaning to be performed by the tile layer:

1 Initial cleaning: about 10-20 minutes after grouting, grout will lose its plasticity and become opaque: any excess sealant should then be removed using a clean, damp sponge. The tiles must then be wiped clean using a dry cloth or felt.

2 Final cleaning: after 36/48 hours both the tiles and the joints will have dried completely: the surface must then be washed using a buffered acid solution. The tiles must then be rinsed using plenty of clean water, which must then be removed using a liquid vacuum.

EXTREMELY IMPORTANT: it is essential that the tile layer cleans the tiles exactly as prescribed so that the flooring will subsequently be easy to clean. The care taken with both the initial and final cleaning processes (in particular the complete removal of grout residuals) will affect the subsequent ease of maintenance of the flooring. The best manufacturers of joint-grouts and adhesives recommend this procedure for all flooring in porcelain stoneware. If these recommendations are not observed or if water is used which is not perfectly clean, it could lead to the formation of a hardly perceivable film of grout or building site dust which is extremely absorbent and captures any dust in the atmosphere and can make the floor look eternally dirty. In this case Fap ceramiche declines any responsibility.

Ordinary cleaning:

3 Frequency: as usual.
Recommendations:

a] always use cleaning tools which are perfectly clean; **b]** always rinse the floor; **c]** do not walk on the floor when wet; **d]** clean water without detergent may be used for frequent washing or specific detergents to remove dirt of stains that are not waxen or filmy. We advise not to use detergents with the indication "it is not necessary to rinse after use".

Cleaning to be carried out by the tile layer.

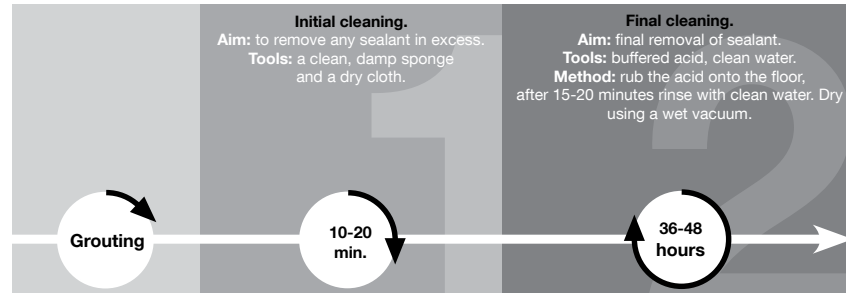

Ordinary cleaning to be carried out by the user.

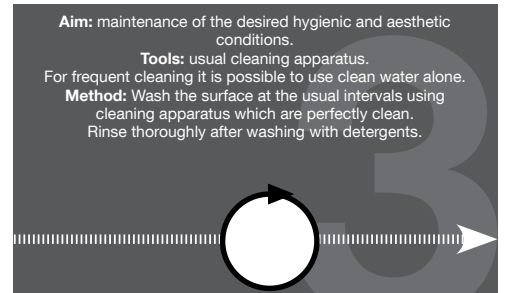

Glossy porcelain stoneware

Glossy porcelain stoneware is created by means of a special polishing process that enhances the smooth texture of the surface of the tiles, thus achieving a sophisticated look in which vibrant reflections create a uniquely attractive effect. The polishing process used for all the polished and lapped products on the market involves removing a tiny part of the material and sometimes opening up a number of micro-pores on the surface, which makes the products more vulnerable to staining. We recommend using grout in a shade similar to that of the tile, in order to reduce contrast. During the laying process, materials should not be marked on the upward facing side with pencils or permanent markers.

Pose, jointoiment, nettoyage

Pâte blanche

IMPORTANT : POUR LA POSE COMME POUR LE JOINTOIEMENT, FAIRE APPEL À DES PROFESSIONNELS.

Pose

Une pose bien faite, dans le respect des règles de l’art, est la garantie d’un résultat parfait:

- contrôler la planéité des murs à revêtir;
- poser le produit en prélevant les carreaux de plusieurs boîtes à la fois;
- manipuler le produit avec précaution avant et pendant la pose.
- Pour la mise en œuvre de ses revêtements, Fap ceramiche préconise l’utilisation d’un mortier colle de classe C2 conforme à la norme européenne EN 12004. Le choix d’un mortier colle blanc anti-glissement pour revêtements céramiques est préférable. L’adjonction d’un agent élastifiant, pour l’emploi duquel les indications fournies par le producteur doivent être scrupuleusement respectées, contribue également à apporter un meilleur résultat. La couche de mortier colle appliquée sur le support doit être homogène. Son épaisseur peut être ajustée en utilisant la face dentée de la taloche.

IMPORTANT:

Les revêtements muraux rectifiés Fap sont conçus et réalisés pour permettre une pose des carreaux à joints unis (sans jointoiments) (sauf normes locales contraires). Cela permet d’obtenir un résultat esthétique meilleur (surfaces ininterrompues) et fonctionnel (le carreau retient moins la saleté).

Jointoiment

Il est conseillé d’utiliser des mortiers dont la couleur est assortie aux carreaux.

Nettoyage

Pour le nettoyage, utiliser des outils parfaitement propres. Toujours rincer les superficies. Pour des lavages fréquents, n’utiliser que de l’eau propre.

Grès Cérame

IMPORTANT : POUR LA POSE COMME POUR LE JOINTOIEMENT, FAIRE APPEL À DES PROFESSIONNELS.

Pose

Une pose bien faite, dans le respect des règles de l’art, est la garantie d’un résultat parfait:

- contrôler la lanéité de la chape sur laquelle les carreaux de sol seront posés;
- poser le produit en prélevant les carreaux de plusieurs boîtes à la foi;
- manipuler le produit avec précaution avant et pendant la pose.

IMPORTANT:

Les revêtements de sol rectifiés Fap doivent être posés avec un joint de 2-3 mm. Pour la pose à l’extérieur, nous recommandons un joint de 3 mm. Pour la pose décalée, ne pas dépasser 1/3 d’espacement entre les carreaux. Les hexagones doivent être posés avec un joint de 3-5 mm.

Jointoiment

Il est conseillé d’utiliser des mortiers dont la couleur est assortie aux carreaux.

Nettoyage

Les consignes de nettoyage (laissé au soin du carreleur) doivent être suivies lorsque sont utilisés des ciments joints. En cas d’utilisation de joints époxy, se conformer aux indications du fabricant.

Nettoyage réalisé par le poseur:

- Premier nettoyage:** lorsque, de 10 à 20 minutes après le jointoiment, le mortier perd de son élasticité et devient opaque, il faut commencer par enlever l’excédent de ciment-joint à l’aide d’une éponge humide et propre. Il faut ensuite effectuer un nettoyage à sec à l’aide d’un chiffon sec ou d’un feutre.

- Nettoyage final:** au bout de 36 à 48 heures, les carreaux et les joints ont achevé leur maturation. Il faut donc procéder au lavage de la surface à l’aide d’un acide à action tamponnée. Il faut ensuite rincer avec une quantité abondante d’eau propre à enlever ensuite à l’aide d’un aspire-liquides.

TRÈS IMPORTANT: il est fondamental que le nettoyage effectué par le poseur soit exécuté dans les règles de l’art pour que le revêtement de sol soit ensuite facile à entretenir. Le soin avec lequel le premier nettoyage et le nettoyage final seront effectués (notamment l’élimination totale des résidus de ciments-joints) sera déterminant pour la facilité d’entretien du sol une fois celui-ci en usage. Cette procédure est prévue par tous les fabricants de colle et de produits de jointoiment pour revêtements de sol en grès cérame. Le non-respect de ces conseils ou l’utilisation d’une eau qui ne serait pas parfaitement propre, peut provoquer l’apparition d’un voile de ciment-joint ou de poussière de chantier, pas toujours visible à l’œil nu, mais qui a la propriété d’emprisonner les taches, les rendant impossible à éliminer. Le sol apparait alors constamment sale.

Nettoyage ordinaire:

- Fréquence:** comme d’habitude.

Avertissements:

a] utiliser des instruments pour le nettoyage parfaitement propres; **b]** toujours rincer le revêtement de sol; **c]** ne pas piétiner le revêtement de sol humide; **d]** pour des lavages fréquents, il est possible d'utiliser tout simplement de l'eau propre ou des nettoyants spécifiques pour éliminer la saleté et les taches, à condition qu’ils ne soient ni cirants ni filmogènes. Il est déconseillé d'utiliser des produits indiquant « ne nécessite pas de rinçage ».

Nettoyage par le carreleur.

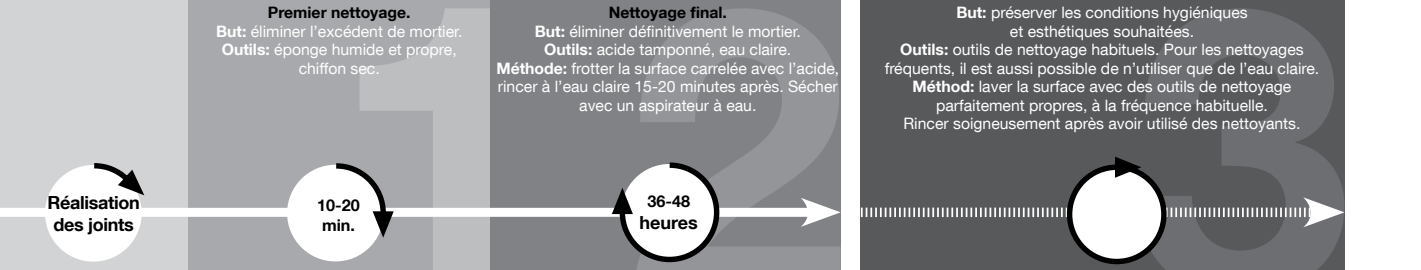

Grès Cérame Brillant

Le Grès Cérame Brillant est réalisé grâce à un procédé spécifique de polissage rehaussant la douceur de la structure de la surface des carreaux. Il est ainsi possible d’obtenir un effet très sophistiqué de palpitantes moirures qui donnent au sol un aspect unique. Le procédé de polissage de tous les produits polis et rodés présents sur le marché, consiste à enlever une petite partie de matériau et à tenter d’ouvrir quelques minuscules pores en surface, les rendant ainsi plus vulnérables aux taches. Il est conseillé d’utiliser des mortiers dont la couleur est assortie aux carreaux, pour réduire le contraste. Au cours de la pose, il est important de ne pas écrire sur les surfaces avec des crayons ou des feutres indélébiles.

Verlegen, Verfugen, Reinigung

Weißscherbig

WICHTIGE VORBEMERKUNG: WENDEN SIE SICH FÜR DIE VERLEGUNG UND VERFUGUNG STETS AN FACHHANDWERKER.

Verlegung

Eine korrekte bauseitige Verlegung unter Beachtung einiger einfacher Regeln garantiert ein perfektes Endergebnis:

- Die Ebenflächigkeit der zu verkleidenden Wände ist zu prüfen;
- Beim Verlegen aus verschiedenen Kartons entnommene Fliesen mischen.
- Das Produkt vor und während der Verlegung vorsichtig handhaben.
- Fap ceramiche empfiehlt, für die Installation ihrer Verkleidungen Kleber der Klasse C2 nach der europäischen Norm EN 12004 zu verwenden. Insbesondere wird der Einsatz von weißem Kleber für rutschfeste Keramikverkleidungen empfohlen. Für ein optimales Ergebnis kann man unter strenger Einhaltung der Herstellerangaben ein Elastifizierungsmittel zufügen. Eine homogene Klebeschicht auf dem Untergrund auftragen. Die Stärke des Klebers kann mit Hilfe der gezahnten Seite der Glättkelle reguliert werden.

WICHTIG:

Die geschliffenen Wandfliesen von Fap wurden entwickelt und gefertigt, um eine fugenlose Verlegung zu erlauben. Dies führt zu einem ausgezeichneten ästhetischen Ergebnis (durchgehende Wandgestaltung) und hat praktische Vorteile (der Schmutz setzt sich nicht so leicht fest, da keine Fugen vorhanden sind).

Verfugung

Außerdem empfehlen wir die Anwendung von Fugenfüllern in den Farbtönen der Fliese.

Reinigung

Verwenden Sie vollständig saubere Reinigungswerkzeuge. Spülen Sie die Flächen immer nach. Für die häufige Reinigung kann auch einfach klares Wasser verwendet werden.

Feinsteinzeug

WICHTIGE VORBEMERKUNG: WENDEN SIE SICH FÜR DIE VERLEGUNG UND VERFUGUNG STETS AN FACHHANDWERKER.

Verlegung

Eine korrekte bauseitige Verlegung unter Beachtung einiger einfacher Regeln garantiert ein perfektes Endergebnis:

- Die Ebenflächigkeit des Estrichs, auf dem die Bodenfliesen verlegt werden, muss geprüft werden;
- Beim Verlegen aus verschiedenen Kartons entnommene Fliesen mischen.
- Das Produkt vor und während der Verlegung vorsichtig handhaben.

WICHTIG:

Die geschliffenen Bodenbeläge von Fap werden mit einer Fuge von 2-3 mm verlegt. Bei der Verlegung im Außenbereich wird eine Fuge von 3 mm empfohlen. Für fortlaufend verlegte Böden beträgt die Versetzung max. 1/3 zwischen den Platten. Die Hexagone müssen mit einer Fuge von 3 bis 5 mm verlegt werden.

Verfugung

Außerdem empfehlen wir die Anwendung von Fugenfüllern in den Farbtönen der Fliese.

Reinigung

Die Regeln für die Reinigung durch den Fliesenleger müssen angewandt werden, wenn zementhaltige Fugenmörtel verwendet werden. Wenn Epoxi-Fugenmassen verwendet werden, sind die Hinweise des Herstellers einzuhalten.

Die Reinigung erfolgt durch den Verleger:

- Erste Reinigung:** wenn nach 10-20 Minuten nach der Verlegung der Mörtel seine Formbarkeit verliert und opak wird, wird mit der Entfernung der überschüssigen Dichtungsmasse mit Hilfe eines feuchten und sauberen Lappens begonnen. Danach muss eine Trockenreinigung mit einem trockenen Tuch oder mit Filz erfolgen.

- Endreinigung:** nach 36/48 Stunden haben sowohl die Fließen als auch die Fugen ihre Ablagerung vollendet. Nun müssen die Oberflächen mit Hilfe einer gepufferten Säure gereinigt werden. Danach muss mit viel sauberem Wasser gespült werden und dann mit einem Flüssigkeitsabsauger entfernt werden.

SEHR WICHTIG: es ist wichtig, dass die Reinigung durch den Fliesenleger ordnungsgemäß durchgeführt wird, damit der Fußboden leicht gewartet wird. Die Sorgfalt, mit der die erste Reinigung und die Endreinigung durchgeführt werden (insbesondere die vollständige Entfernung von Mörtelresten) beeinflusst die Pflegbarkeit des Fußbodens. Diese Prozedur wird von den besten Fugenmörtel- und Klebstoffherstellern für alle Fußböden aus Feinsteinzeug empfohlen. Werden diese Empfehlungen nicht beachtet oder wird nicht absolut reines Wasser verwendet, so kann dies zum Entstehen einer Mörtelpatina oder einer Baustellenstaubschicht, die extrem Saugfähig ist, führen, die mit bloßem Auge nicht erkennbar ist, aber im Raum vorhandenen Staub fängt und zu einem ständig schmutzigen Fußboden führt. In diesem Falle lehnt Fap ceramiche jegliche Verantwortung ab.

Normale Reinigung:

- Frequenz:** wie üblich.

Hinweise:

a] Verwenden Sie absolut saubere Reinigungsmittel; **b]** Waschen Sie den Fußboden immer ab; **c]** Nicht den nassen Fußboden betreten;

d] Bei häufigem Waschen braucht man nur sauberes Wasser oder spezifische Reinigungsmittel um Schmutz oder Flecken zu entfernen, die nicht wächsern oder filmförmig sind. Wir empfehlen keine Reinigungsmittel zu verwenden mit dem Hinweis „muss nicht nachgespült werden“.

Reinigung und Pflege durch den Fliesenleger.

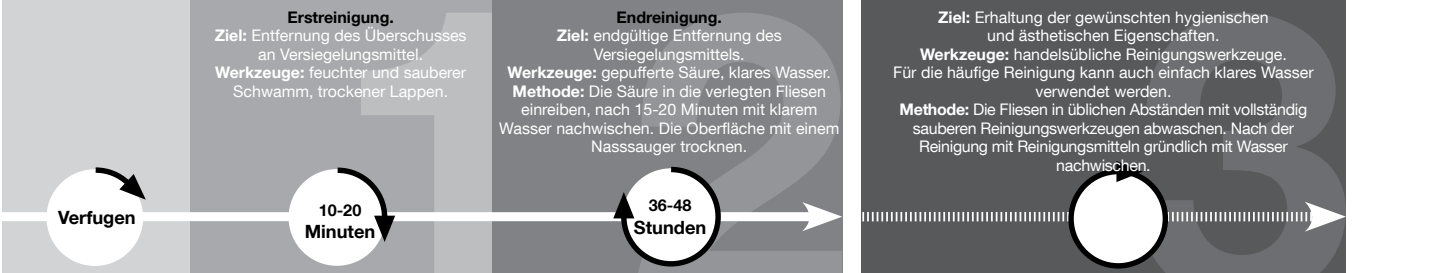

Glänzendes Feinsteinzeug

Das glänzende Feinsteinzeug wird mit einem speziellen Polierverfahren verwirklicht, das die weiche Struktur der Fliesenoberfläche hervorhebt. So wird ein spezieller Effekt mit vibrierenden Reflexen erhalten, die den Boden einzigartig gestalten. Das Polierverfahren aller auf dem Markt angebotenen geschliffenen und geläppten Produkte erfolgt durch die Entfernung eines geringen Materialteils und die somit mögliche Öffnung einiger oberflächlicher Mikroporen, wodurch das Produkt fleckenempfindlicher wird. Außerdem empfehlen wir die Anwendung von Fugenfüllern in den Farbtönen der Fliese, um Kontraste einzuschränken. Während des Verlegens darf das Material auf der Oberfläche nicht mit unlöschbaren Stiften beschriftet werden.

Colocación, rejuntado, limpieza

Pasta blanca

PREMISA IMPORTANTE: DIRÍJANSE A PROFESIONALES DEL SECTOR PARA LAS OPERACIONES DE COLOCACIÓN Y REJUNTADO.

Colocación

Una colocación en obra correcta, siguiendo algunas reglas sencillas, garantizará un resultado final perfecto:

- controlar la planitud de las paredes a revestir;
- colocar el producto mezclando el material extraído de varias cajas;
- manejar el producto con cuidado antes y durante la colocación.
- Para la colocación de sus piezas de revestimiento cerámico FAP Ceramiche le recomienda usar un compuesto adhesivo de Clase C2 según la Norma Europea EN 12004. En particular, le sugiere usar un adhesivo blanco para revestimientos cerámicos antideslizantes. Añadir un compuesto elastizante le permitirá obtener un excelente resultado. Cuando use este tipo de agentes respete escrupulosamente las instrucciones de su fabricante. Aplique siempre una capa homogénea de adhesivo sobre la superficie a revestir. Use el lado dentado de un fratás para regular el espesor del adhesivo.

IMPORTANTE:

Los revestimientos rectificados de Fap son diseñados y fabricados para consentir una colocación muy cercana (sin juntas) de los azulejos. Ello permite obtener el mejor resultado estético (paredes continuas) y funcional (al no haber juntas, no retiene la suciedad).

Rejuntado

Se recomienda utilizar material de rejuntado de color similar a la baldosa.

Limpieza

Utilizar instrumentos para la limpieza perfectamente limpios. Enjuagar siempre las superficies. Utilizar simplemente agua limpia para realizar lavados frecuentes.

Gres Porcelánico

PREMISA IMPORTANTE: DIRÍJANSE A PROFESIONALES DEL SECTOR PARA LAS OPERACIONES DE COLOCACIÓN Y REJUNTADO.

Colocación

Una colocación en obra correcta, siguiendo algunas reglas sencillas, garantizará un resultado final perfecto:

- controlar la planitud de la placa sobre la que colocar las baldosas;
- colocar el producto mezclando el material extraído de varias cajas;
- manejar el producto con cuidado antes y durante la colocación.

IMPORTANTE:

Los pavimentos rectificados de Fap deberán colocarse con una junta de 2-3 mm. Para la colocación al exterior se recomienda una junta de 3 mm.

Para pavimentos con colocación recta, diferencia máxima de 1/3 entre las planchas. Los hexágonos se deberán colocar con una junta de 3 a 5 mm.

Rejuntado

Se recomienda utilizar material de rejuntado de color similar a la baldosa.

Limpieza

Las reglas para la limpieza llevada a cabo por el solador deberán aplicarse cuando se utilicen materiales de relleno cementosos. Cuando se utilicen materiales de relleno epoxi, deberán seguirse las indicaciones de los fabricantes.

Limpieza a cargo del alicatador/solador:

- Primera limpieza:** ddespués de 10-20 minutos del rejuntado, cuando el material de relleno pierde plasticidad y se vuelve opaco, quitar el exceso del sellante con una esponja húmeda y limpia. Efectuar luego una limpieza en seco con un paño seco o con un fieltro.

- Limpieza final:** pasadas 36/48 horas, tanto los azulejos como las juntas habrán terminado de secarse y deberá procederse al fregado de la superficie con un ácido de acción tamponada. Aclarar luego con abundante agua limpia, que se retirará con una aspiradora de líquidos.

IMPORTANTÍSIMO: es fundamental que esta limpieza sea llevada a cabo correctamente por el alicatador/solador para que el pavimento pueda ser luego sometido fácilmente a las operaciones de mantenimiento. El cuidado con el que se efectúen la primera limpieza y la limpieza final (especialmente la retirada total de los materiales residuales de rejuntado) influenciarán la facilidad de limpieza del pavimento. Dicho procedimiento está previsto por los mejores fabricantes de materiales de rejuntado y adhesivos para todos los pavimentos de gres porcelánico. El incumplimiento de estas recomendaciones, o emplear agua no totalmente limpia, puede determinar la fijación de una pátina de material de rejuntado o de polvo de la obra extremamente absorbente, no perfectamente visible a simple vista, que captura el polvo existente en el ambiente y que puede hacer que el pavimento esté siempre sucio. En este caso Fap ceramiche declina cualquier responsabilidad.

Pulizia ordinaria.

- Frecuencia:** la habitual.

Advertencias:

a] utilizar herramientas para la limpieza totalmente limpias; **b]** aclarar siempre el pavimento; **c]** no pisar el pavimento mojado;

d] para efectuar lavados frecuentes podrá utilizarse simplemente agua limpia o detergentes específicos para quitar la suciedad o las manchas que no sean de cera o películas. Desaconsejamos utilizar productos con la indicación “no necesita enjuague”.

Limpieza a cargo del colocador.

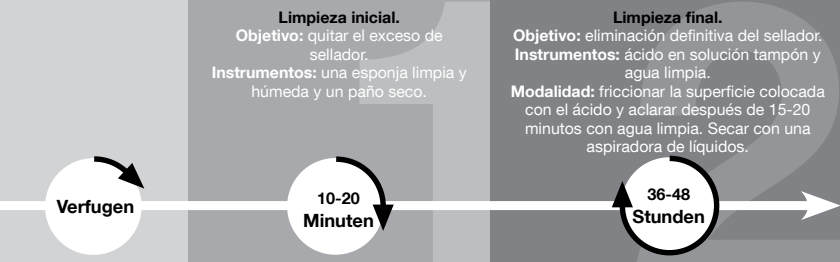

Gres Porcelánico Brillante

El gres porcelánico Brillante está realizado con un proceso especial de lustrado que remarca la estructura suave de la superficie de las baldosas. Así se obtiene un sofisticado efecto de reflejos vibrantes que donan unicidad al pavimento. El proceso de lustrado de todos los productos lustrados y pulidos presentes en el mercado, se realiza eliminando una pequeña parte de material y abriendo algunos microporos sobre la superficie, haciendo que el producto sea más sensible a las manchas. Se recomienda utilizar material de rejuntado de color similar a la baldosa para reducir el contraste. Durante la colocación no se debe marcar el material con lápices o rotuladores indelebles sobre la superficie de uso.

Укладка,шпаклевание, уход.

Белая масса

Важное замечание: для укладки и затирки швов следует обращаться к профессиональным плиточникам.

УКЛАДКА

Правильная укладка с соблюдением некоторых простых правил обеспечит хороший конечный результат:

- проконтролировать ровность стен перед укладкой;
- при укладке следует использовать плитки из разных коробок;
- аккуратно обращаться с плиткой до укладки и в процессе работы.
- Для укладки настенной плитки собственного производства компания Far ceramiche рекомендует использовать клей класса C2 в соответствии с Европейской Нормой EN 12004. В частности, рекомендуется применять белый клей для керамических противоскользящих покрытий. В целях достижения оптимального результата используйте эластичную эмульсию, внимательно следуя указаниям производителя. На основание необходимо нанести однородный слой клей. Толщина клея измеряется при помощи зубчатого края шпателя.

ВАЖНО:

Ректифицированная облицовочная плитка Far спроектирована и произведена для укладки встык (без швов). Это позволяет получить лучший эстетический (сплошная стена) и функциональный (благодаря отсутствию швов, не задерживает грязь) результат.

ЗАТИРКА ШВОВ

Для уменьшения цветового контраста рекомендуется применять затирку, соответствующую цвету плитки.

ЧИСТКА

Во время уборки использовать только чистую губку или тряпку. Для частой уборки применять просто чистую воду.

Керамогранит

Важное замечание: для укладки и затирки швов следует обращаться к профессиональным плиточникам.

УКЛАДКА

Правильная укладка с соблюдением некоторых простых правил обеспечит хороший конечный результат:

- проконтролировать ровность стяжки, на которую будет укладываться напольная плитка;
- при укладке следует использовать плитки из разных коробок;
- аккуратно обращаться с плиткой до укладки и в процессе работы.

ВАЖНО:

Ректифицированную напольную плитку Far необходимо укладывать со швом 2-3 мм. Для укладки плитки на улице рекомендуемая ширина шва – 3мм. Для полов при укладке со смещением, максимальное смещение между досками должно быть не более 1/3. Укладку шестигранной плитки необходимо осуществлять с учетом шва 3-5 мм.

ЗАТИРКА ШВОВ

Для уменьшения цветового контраста рекомендуется применять затирку, соответствующую цвету плитки.

УБОРКА

Укладчик плитки должен соблюдать соответствующие правила очистки в случае использования цементных затирок. В случае использования эпоксидных затирок следует придерживаться правил, установленных производителем.

Очистка выполняется укладчиком:

- Первая очистка:** по истечении 10-20 минут после оштукатуривания затирка теряет пластичность и становится матовым. Далее необходимо удалить излишек герметизирующего состава с помощью чистой влажной губки. Затем необходимо осуществить очистку сухой тряпкой или кусочком фетра.

- Конечная очистка:** через 36/48 часов как плитка, так и швы завершают свое созревание, далее необходимо приступить к очистке поверхности с применением кислоты тампонажного действия. После этого необходимо сполоснуть поверхность большим количеством чистой воды и удалить ее с помощью машины для отсасывания жидкостей.

ОЧЕНЬ ВАЖНО: крайне важно, чтобы очистка выполнялась укладчиком искусно и по всем правилам, чтобы за полом было легко ухаживать. Тщательность, с которой выполняется первая и конечная уборка (в особенности полное удаление остатков штукатурки) будет влиять на способность пола к очистке. Данная процедура предусматривается лучшими производителями штукатурки для швов и клеящих веществ, для всех напольных покрытий из керамогранита. Несоблюдение этих рекомендаций или использование не совсем чистой воды может спровоцировать закрепление налета из штукатурки или строительной пыли с повышенной абсорбирующей способностью, не очень видимой на глаз, которая поглощает существующую в среде пыль и пол может казаться всегда грязным. В этом случае компания Far ceramiche снимает с себя всякую ответственность.

Обычная очистка:

3 Частота: как обычно.

Рекомендации:

a] Использовать абсолютно чистые инструменты для уборки; **b]** Всегда споласкивать пол **c]** Не ходить по мокрому полу;

d] Для частой очистки можно просто использовать чистую воду или невосковые, не образующие плёнку и налёт моющие средства, предназначенные для удаления грязи и пятен. Не рекомендуется использование средств с указанием «без ополаскивания».

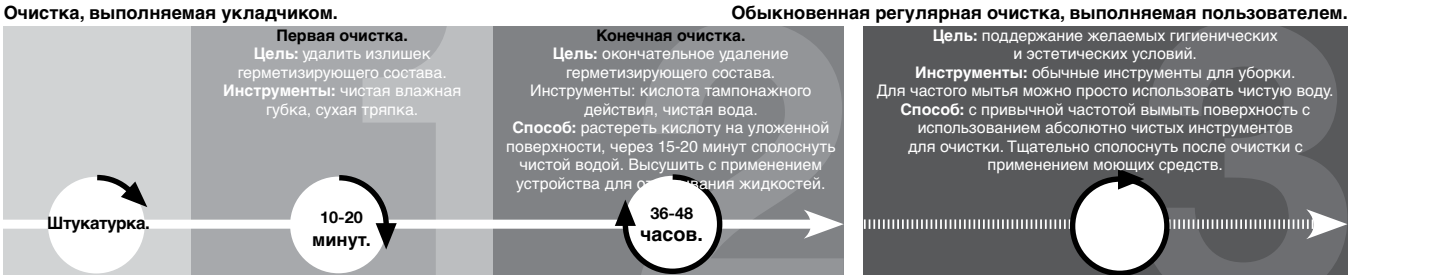

Глянцевый керамогранит

Глянцевый керамогранит выполнен с применением специальной полировочной техники, подчеркивающей мягкость плиточной поверхности. В результате достигается изысканный эфффект переливчатости бликов, придающих полу неповторимость. Полировочная техника, применённая на всех предлагаемых на рынке отшлифованных и притёртых изделиях, заключается в удалении небольшого количества материала и в максимальном открытии микропор на поверхности, что делает плитку более уязвимой для грязевых пятен. Для уменьшения цветового контраста рекомендуется применять затирку, соответствующую цвету плитки. Во время укладки запрещается делать пометки на поверхности плитки несмываемыми карандашами или фломастерами.

Test

Pasta Bianca - Standard EN 14411 (ISO 13006) Annex L Group BIII, E_b > 10%

White body. / Weißscherbiger. / Pâte blanche. / Pasta blanca. / Белой глины.

CARATTERISTICHE TECNICHE TECHNICAL SPECIFICATIONS CARACTERISTIQUES TECHNIQUES TECHNISCHE EIGENSCHAFTEN CARACTERÍSTICAS TÉCNICAS ТЕХНИЧЕСКИЕ ХАРАКТЕРИСТИКИ		NORME STANDARDS NORMES NORMEN NORMAS НОРМЫ	VALORE PRESCRITTO VALUES REQUIRED VALEUR PRESCRITE NORMVORGABE VALOR PRESCRITO ЗАДАННОЕ ЗНАЧЕНИЕ EN 14411 - ISO 13006 BIII (GL)	VALORE MEDIO FAP • AVERAGE FAP RATING VALEUR MOYENNE FAP DURCHSCHNITTSWERT FAP VALOR MEDIO FAP СРЕДНЕЕ ЗНАЧЕНИЕ FAP BIII
DIMENSIONI SIZES DIMENSIONS GRÖSSEN DIMENSIONES РАЗМЕРЫ		Lunghezza e larghezza Length and width / Dimensions des côtés / Seitenlänge / Largo y ancho / Длина и ширина	± 0,5%, max 2 mm	Conforme In accordance
		Spessore Thickness / Epaisseur / Stärke / Espesor / Толщина	± 10%, max 0,5 mm	Conforme In accordance
		Ortogonalità Wedging / Orthogonalité / Rechtwinkligkeit / Ortogonalidad / Ортогональность	± 0,5%, max 2 mm	Conforme In accordance
		Rettilineità degli spigoli Straightness of the edges / Equerrage des angles / Kantengeradheit / Rectilinearidad de las aristas / Прямолинейность углов	± 0,3%, max 1,5 mm	Conforme In accordance
		Planarità Flatness / Planéité / Oberflächenqualität / Planicidad / Плоскостность	+ 0,5% (max 2,0 mm) -0,3% (max -1,5 mm)	Conforme In accordance
		Aspetto della superficie % senza difetti nel lotto di prova Quality of the surface Faultless % within the sample lot / Qualité de la surface % sans défauts dans le lot d'essai / Oberflächenqualität % an fehlerfreien Fliesen im Prüfbett / Aspecto de la superficie % sin defectos en el lote de prueba / Вид поверхности % без брака в пробной партии	≥ 95%	Conforme In accordance
STRUTTURA STRUCTURE STRUCTURE STRUKTUR ESTRUCTURA СТРУКТУРА		Assorbimento d'acqua - valore medio % Water absorption - average value % / Absorption d'eau - valeur moyenne % / Wasseraufnahme - Durchschnittswert % / Absorción de agua - valor medio % / Водопоглощение Среднее значение %	ISO 10545-3 > 10%	Conforme In accordance
		Sforzo di rottura Breaking strength / Force de rupture / Bruchlast / Esfuerzo de ruptura / Усилие на излом	ISO 10545-4 S ≥ 600 N	Conforme In accordance
		Resistenza alla flessione Bending strength / Résistance à la flexion / Biegefestigkeit / Resistencia a la flexión / Прочность при изгибе	R≥12	Conforme In accordance
SBALZI TERMICI THERMAL SHOCK ECARTS DE TEMPERATURE TEMPERATURWECHSEL CHOQUES TÉRMICOS ТЕМПЕРАТУРНЫЕ ПЕРЕПАДЫ		Resistenza agli sbalzi termici Thermal shock resistance / Resistance aux variations thermiques / Temperaturwechselbeständigkeit / Resistencia a las diferencias de temperatura / Сопротивление температурным перепадам	ISO 10545-9	Conforme In accordance
		Resistenza al cavillo Crazing resistance / Résistance aux craquelures / Haarriß-Beständigkeit / Resistencia al cuarteado / Сопротивляемость образованию кракелюров	ISO 10545-11	Conforme In accordance
SUPERFICIE SURFACE SURFACE OBERFLÄCHE SUPERFICIE ПОВЕРХНОСТЬ		Resistenza ai prodotti chimici di uso domestico e agli additivi per piscina Resistance to household chemicals and swimming pool salts / Résistance aux produits chimiques à usage domestique et aux adjuvants pour piscines / Beständigkeit gegen Haushaltchemikalien und Badewasserzusätze / Resistencia a los productos químicos de uso domestico o productos para la piscina / Сопротивляемость химическим средствам домашнего применения и добавкам для бассейна.	ISO 10545-13 GB Min.	Conforme In accordance
		Resistenza a basse concentrazioni di acidi ed alcali Resistance to low concentrations of acids and alkalis / Résistance aux acides et aux alcalis à basse concentration / Beständigkeit gegen niedrigkonzentrierte Säuren und Laugen / Resistencia a concentración baja de acidos y alcali / Сопротивляемость кислотам и щелочам низкой концентрации	GLB Min.	
		Resistenza alle macchie Stain resistance / Résistance aux taches / Baständigkeit gegen Fleckenbildung / Resistencia a las manchas / Стойкость к загрязнению	ISO 10545-14 MINIMUM CLASS 3	5

- Valore medio dei test condotti negli ultimi 24 mesi. Average rating of tests conducted during the last 24 months. Durchschnittswert der in den letzten 24 Monaten durchgeführten Tests. Valeur moyenne des essais menés au cours des 24 derniers mois. Valor medio de las pruebas llevadas a cabo en los últimos 24 meses. Среднее значение испытаний, проведенных в течение последних 24 месяцев.

Test

Gres Porcellanato colorato in massa - Standard EN 14411 (ISO 13006) Annex G Group BIa, E_b ≤ 0,5%

Full-body coloured porcelain. / Grès cérame coloré pleine masse. / Durchgefärbtes Feinsteinzeug. / Gres porcelánico coloreado en toda la masa. / Керамогранит окрашенный в массе.

CARATTERISTICHE TECNICHE TECHNICAL SPECIFICATIONS CARACTERISTIQUES TECHNIQUES TECHNISCHE EIGENSCHAFTEN CARACTERÍSTICAS TÉCNICAS ТЕХНИЧЕСКИЕ ХАРАКТЕРИСТИКИ		NORME STAN- DARDS NORMES NORMEN NORMAS НОРМЫ	VALORE PRESCRITTO VALUES REQUIRED VALEUR PRESCRITE NORMVORGABE VALOR PRESCRITO ЗАДАННОЕ ЗНАЧЕНИЕ EN 14411 - ISO 13006 BIa (UGL e GL)	FAP - VALORE MEDIO • AVERAGE RATING VALEUR MOYENNE DURCHSCHNITTSWERT VALOR MEDIO СРЕДНЕЕ ЗНАЧЕНИЕ BIa UGL			
				MATT LUX			
DIMENSIONI SIZES DIMENSIONS GRÖSSEN DIMENSIONES РАЗМЕРЫ		Lunghezza e larghezza Length and width / Dimensions des côtés / Seitenlänge / Largo y ancho / Длина и ширина	± 0,6%, max 2 mm	Conforme In accordance	Conforme In accordance		
		Spessore Thickness / Epaisseur / Stärke / Espesor / Толщина	± 5%, max 0,5 mm	Conforme In accordance	Conforme In accordance		
		Ortogonalità Wedging / Orthogonalité / Rechtwinkligkeit / Ortogonalidad / Ортогональность	± 0,5%, max 2 mm	Conforme In accordance	Conforme In accordance		
		Rettilineità degli spigoli Straightness of the edges / Equerrage des angles / Kantengeradheit / Rectilinearidad de las aristas / Прямолинейность углов	± 0,5%, max 1,5 mm	Conforme In accordance	Conforme In accordance		
		Planarità Flatness / Planéité / Oberflächenqualität / Planicidad / Плоскостность	± 0,5%, max 2 mm	Conforme In accordance	Conforme In accordance		
STRUTTURA STRUCTURE STRUCTURE STRUKTUR ESTRUCTURA СТРУКТУРА		Assorbimento d'acqua - valore medio % Water absorption - average value % / Absorption d'eau - valeur moyenne % / Wasseraufnahme - Durchschnittswert % / Absorción de agua - valor medio % / Водопоглощение Среднее значение %	ISO 10545-3 ASTM C373 ≤ 0,5%	Conforme In accordance	Conforme In accordance		
		Sforzo di rottura Breaking strength / Force de rupture / Bruchlast / Esfuerzo de ruptura / Усилие на излом	ISO 10545-4 S ≥ 1300 N		S ≥ 2000 N	S ≥ 2000 N	
		Resistenza alla flessione Bending strength / Résistance à la flexion / Biegefestigkeit / Resistencia a la flexión / Прочность при изгибе	R ≥ 35 N/mm ²	Conforme In accordance	Conforme In accordance		
SBALZI TERMICI THERMAL SHOCK ECARTS DE TEMPERATURE TEMPERATURWECHSEL CHOQUES TÉRMICOS ТЕМПЕРАТУРНЫЕ ПЕРЕПАДЫ		Abrasion profonda Deep abrasion / Abrasion profonde / Tiefenabrieb / Abrasión profunda / Глубокое истирание	ISO 10545-6 ≤ 175mm ³		≤ 140mm ³	≤ 140mm ³	
		Coefficiente di dilatazione termica lineare Coefficient of thermal linear expansion / Coefficient de dilatation thermique linear / Wärmeausdehnungskoeffizient / Coeficiente de dilatación termica linear / Коэффициент теплового линейного расширения	ISO 10545-8 Metodo di prova disponibile / Valore dichiarato / Declared value Test method available / Méthode d'essai disponible / Verfügbare Prüfmethode / Método de prueba disponible / Доступный метод испытания	≤ 7 MK ⁻¹	≤ 7 MK ⁻¹		
RESISTENZA CHIMICA CHEMICAL RESISTANCE RÉSISTANCE AUX ATTAQUES CHIMIQUES CHEMIKALIENFESTIGKEIT RESISTENCIA A LOS PRODUCTOS QUÍMICOS ХИМИЧЕСКАЯ СТОЙКОСТЬ		Resistenza agli sbalzi termici Thermal shock resistance / Resistance aux variations thermiques / Temperaturwechselbeständigkeit / Resistencia a las diferencias de temperatura / Сопротивление температурным перепадам	ISO 10545-9	Resistente Resistant	Resistente Resistant		
		Resistenza al gelo Resistance to frost / Résistance au gel / Frostbeständigkeit / Resistencia al hielo / Морозостойчивость	ISO 10545-12	Resistente Resistant	Resistente Resistant		
		Resistenza ai prodotti chimici di uso domestico e agli additivi per piscina Resistance to household chemicals and swimming pool salts / Résistance aux produits chimiques à usage domestique et aux adjuvants pour piscines / Beständigkeit gegen Haushaltchemikalien und Badewasserzusätze / Resistencia a los productos químicos de uso domestico o productos para la piscina / Сопротивляемость химическим средствам домашнего применения и добавкам для бассейна.	ISO 10545-13	UB Min.	Conforme In accordance	Conforme In accordance	
RESISTENZA CHIMICA CHEMICAL RESISTANCE RÉSISTANCE AUX ATTAQUES CHIMIQUES CHEMIKALIENFESTIGKEIT RESISTENCIA A LOS PRODUCTOS QUÍMICOS ХИМИЧЕСКАЯ СТОЙКОСТЬ		Resistenza ai prodotti chimici di uso domestico e agli additivi per piscina Resistance to household chemicals and swimming pool salts / Résistance aux produits chimiques à usage domestique et aux adjuvants pour piscines / Beständigkeit gegen Haushaltchemikalien und Badewasserzusätze / Resistencia a los productos químicos de uso domestico o productos para la piscina / Сопротивляемость химическим средствам домашнего применения и добавкам для бассейна.	ISO 10545-13	In funzione dell'ambiente o della zona di lavoro. According to the space or the working area / Selon le lieu concerné ou la zone de travail / Je nach Raum oder Arbeitszone / Según el ambiente o de la zona de trabajo / В зависимости от среды или рабочей зоны	R9	-	
		Resistenza a basse concentrazioni di acidi ed alcali Resistance to low concentrations of acids and alkalis / Résistance aux acides et aux alcalis à basse concentration / Beständigkeit gegen niedrigkonzentrierte Säuren und Laugen / Resistencia a concentración baja de acidos y alcali / Сопротивляемость кислотам и щелочам низкой концентрации	ISO 10545-13	ULB Min.		ULB Min.	ULB Min.
		Resistenza alle macchie Stain resistance / Résistance aux taches / Baständigkeit gegen Fleckenbildung / Resistencia a las manchas / Стойкость к загрязнению	ISO 10545-14	5	Metodo di prova disponibile / Valore dichiarato / Declared value Test method available / Méthode d'essai disponible / Verfügbare Prüfmethode / Método de prueba disponible / Доступный метод испытания	5	5

- Valore medio dei test condotti negli ultimi 24 mesi. Average rating of tests conducted during the last 24 months. Durchschnittswert der in den letzten 24 Monaten durchgeführten Tests. Valeur moyenne des essais menés au cours des 24 derniers mois. Valor medio de las pruebas llevadas a cabo en los últimos 24 meses. Среднее значение испытаний, проведенных в течение последних 24 месяцев.

VShade

La classificazione VShade indica il livello di stonalizzazione del prodotto: la variazione cromatica tra le piastrelle di una stessa collezione. Nella tabella sottostante sono indicate le classi di stonalizzazione: / The VShade ranking indicates the level of shading of the product: the variations in colour between the tiles in the same collection. The table below shows the shading classes: / La classification VShade indique le niveau de dénuançage du produit : la variation chromatique entre les carreaux d'une même collection. Dans le tableau ci-après sont indiquées les classes de dénuançage: / Die Einstufung VShade gibt die Abtönungsstufe des Produkts an: Die farbliche Abänderung zwischen den einzelnen Fliesen innerhalb einer Kollektion. In der nachstehenden Tabelle werden die Abtönungsklassen angeführt: / La clasificación VShade indica el nivel de destonalización del producto: la variación cromática entre las baldosas de una misma colección. En la tabla de abajo se indican las clases de destonalización: / Классификация VShade указывает на градацию тонов продукции – цветовую вариацию плитки в рамках одной коллекции. В приведенной ниже таблице указаны уровни различий тонов:

V1

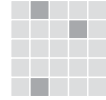

Leggera
Light
Légère
Leicht
Ligera
Низкий

V2



Moderata
Moderate
Modérée
Mäßig
Moderada
Средний

V3



Alta
High
Élevée
Hoch
Alta
Значительный

V4



Forte
Very High
Forte
Stark
Fuerte
Высокий

I colori e le caratteristiche estetiche dei materiali illustrati nel presente catalogo sono da ritenersi puramente indicativi.
Colours and optical features of the materials illustrated in this catalogue are to be regarded as mere indications.
Die Farben und die ästhetischen Eigenschaften der in diesem Katalog abgebildeten Produkte sind als reine Richtwerte zu betrachten.
Les coloris et les caractéristiques esthétiques des références illustrées dans le catalogue sont donnés à titre purement indicatif.
Los colores y las características ópticas de los materiales ilustrados en este catálogo deben ser mirados como indicaciones meras.
Цвета и эстетические характеристики описанных в настоящем каталоге материалов являются только ориентировочными.

Fap ceramiche si riserva di apportare modifiche e/o eliminare senza preavviso i prodotti declinando ogni responsabilità per danni diretti o indiretti derivanti da eventuali modifiche.
Fap ceramiche can change the indicated products without notice declining any responsibility for direct or indirect damage that depend on these changes.
Fap ceramiche se réserve le droit de modifier sans préavis les produits indiqués et décline toute responsabilité pour dommages directs ou indirects dus à éventuelles modifications.
Fap Ceramiche se reserva la facultad de modificar los productos sin preaviso, declinando cualquier responsabilidad por daños directos o indirectos que dependan de estos cambios.
Fap ceramiche kann die genannten Produkten ändern ohne Voranmeldung und lehnt dabei jegliche Verantwortung für die davon abhängenden direkten oder indirekten Schäden ab.
Компания "Fap ceramiche" сохраняет за собой право на внесение изменений в продукцию без предварительного уведомления, снимая с себя всякую ответственность за связанный с этими изменениями прямой или не прямой ущерб.

Fap ceramiche - 2nd edition January 2016 - 1st edition September 2015

È vietata la riproduzione anche parziale dell'opera in tutte le sue forme.
Reproduction of this printed catalogue, even partially, is prohibited.





**MOSCOW
SHOWROOM**

Via Ghiarola Nuova, 44 - 41042 Fiorano Modenese (MO) Italy
tel. +39 0536 837511 - fax +39 0536 837532 - fax estero +39 0536 837542
www.fapceramiche.com - info@fapceramiche.com



Hamovnichevskiy Val, 36 - Moscow Metro / Sportivnaya tel. +7 (495) 775 05 20
www.fapceramiche.ru - moscow@fapceramiche.com