

GRESPLUS

GRES FINE PORCELLANATO

ALABASTRO
CASATI
COCCIO
COTTO GERATO
EUROPA
FLORIDA
LINO
LOUNGE
MARMOREA
MITI
OLD SEASON
PALATINO
PIANETI
RAPOLANO
ROCKS



CASALGRANDE
PADANA
Pave your way



Ceramic Tiles of Italy



www.casalgrandepadana.com



CASALGRANDE
PADANA

Pave your way

GRESPLUS

GRES FINE PORCELLANATO

- 4 **Alabastro**
- 8 **Casati**
- 11 **Coccio**
- 12 **Cotto Cerato**
- 14 **Europa**
- 16 **Florida**
- 20 **Lino**
- 22 **Lounge**
- 24 **Marmorea**
- 28 **Miti**
- 30 **Old Season**
- 32 **Palatino**
- 38 **Pianeti**
- 40 **Rapolano**
- 44 **Rocks**

- 46 **Caratteristiche tecniche**
Technical features
Caractéristiques techniques
Technische eigenschaften

- 48 **Pesi, misure e contenuto dei colli**
Weight, size and contents of the packing
Poids, dimensions, contenu des colis
Verpackungsgrößen/gewichte



GRESPLUS

Gres Fine Porcellanato

Casalgrande Padana, azienda leader nella ricerca e produzione del grès porcellanato, ha realizzato la sintesi di forza e bellezza. **Gresplus** nasce come evoluzione della tradizionale monocottura smaltata, cui unisce le caratteristiche tecniche del migliore grès porcellanato. La base in grès porcellanato subisce un processo di fusione con serigrafie ad altissime temperature, ciò rende Gresplus un materiale resistentissimo all'usura, alla flessione, al gelo e alle sostanze macchianti.

Casalgrande Padana is a leading company in the research and production of porcelain stoneware and has matched strength and beauty in this product. **Gresplus** has been developed as evolution of the traditional glazed single-firing, combined with the technical features of the best porcelain stoneware. The support in porcelain stoneware undergoes a melting process with transfers at very high temperatures, so that Gresplus is extremely resistant to wear, flexure, frost and staining agents.

Casalgrande Padana, marque leader dans le domaine de la recherche et de la production du grès cérame, a réunit et synthétisé force et beauté. La série **Gresplus** naît de l'évolution des monocuissons émaillées traditionnelles, auxquelles elle ajoute les caractéristiques techniques du meilleur grès cérame. La base, en grès cérame, subit un procédé de fusion avec sérigraphies à des températures très élevées, qui fait de Gresplus un des matériaux les plus résistants à l'usure, à la flexion, au gel et aux taches.

Casalgrande Padana, der leitende Betrieb im Bereich der Forschung und Produktion von Feinsteinzeug, hat die Synthese zwischen Stärke und Schönheit realisiert. **Gresplus** wird als Evolution des herkömmlichen glasierten Einbrandes entworfen, zu dem die technischen Eigenschaften des glasierten Feinsteinzeuges gehören. Der Feinsteinzeugscherben ist einem Verschmelzungsverfahren bei Siebdruck unter hohen Temperaturen ausgesetzt und das macht aus Gresplus ein hoch abnutzungs-, biege-, frost- und fleckenbeständiges Material.



Ivory, lappato cm 33x33, listone e tozzetto

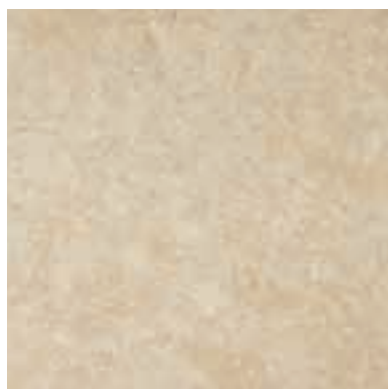

Cream Matt



64 Cream Lappato

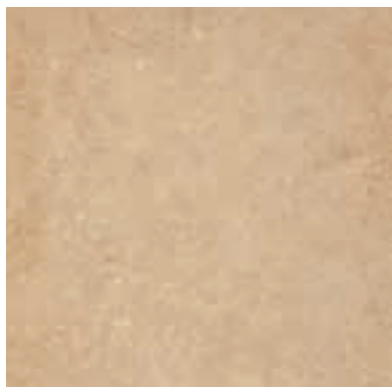

Caramel matt

G4



Caramel lappato



Ivory matt

G4



Ivory lappato



Honey matt

G4



Honey lappato

TABELLA RIASSUNTIVA FORMATI-SUPERFICI-SPESSORI
TABLE SUMMARISING SIZES-SURFACES-THICKNESSES
TABLEAU RECAPITULATIF DES FORMATS-SURFACES-EPAISSEURS
ZUSAMMENFASSENDE TABELLE FORMATE-OBERFLÄCHEN-STÄRKEN



cm 33x33 - 13"x13"

Formati Sizes **Formats** **Formate**

Superfici Surfaces **Surfaces** **Oberflächen**



Spessori Thicknesses **Epaisseurs** **Stärken**

mm 8,3

● Naturale **Matt** Naturelle Natur ● Lappata

DECORI DECORS DECORS DEKORE



*Fascia marmo Alabastro
cm 2,5x33 - 1"x13"



Listone
cm 10x33 - 4"x13"



Tozzetto
cm 10x10 - 4"x4"



Fascia
cm 16,5x33 - 6 $\frac{1}{2}$ "x13"



Angolo
cm 16,5x16,5 - 6 $\frac{1}{2}$ "x6 $\frac{1}{2}$ "



Le piastrelle della serie Alabastro possono essere fornite con uno o più angoli tagliati, per creare varie composizioni insieme al tozzetto. The tiles in the Alabastro series can be supplied with one or more corners cut so that different laying patterns can be created with the inserts. Les carreaux de la série Alabastro peuvent être fournis avec un ou plusieurs angles découpés, de façon à pouvoir réaliser différentes compositions avec le cabochon. Die Fliesen der Serie Alabastro können mit einer oder mehreren abgeschnittenen Ecken geliefert werden, sodass mit den Einlegern verschiedene Gestaltungen möglich sind.

*Marmo naturale Natural marble Marbre naturel Natur Marmor



Cream, matt, cm 33x33, fascia marmo Alabastro

DECORI DECORS DECORS DEKORE



Fascia Classica Riposo
Honey/Ivory/Caramel
cm 16,5x33 - 6 $\frac{1}{2}$ "x13"



Fascia Classica decoro
Honey/Ivory/Caramel
cm 16,5x33 - 6 $\frac{1}{2}$ "x13"



Angolo Classica
Honey/Ivory/Caramel
cm 16,5x16,5 - 6 $\frac{1}{2}$ "x6 $\frac{1}{2}$ "

SCHEMI DI POSA LAYOUT SOLUTIONS
CALPINAGES DE POSE VERLEGUNGSSPIELE

cm 33x33 = 91,5%
cm 10x10 = 8,5%



cm 33x33 = 95%
cm 10x10 = 5%

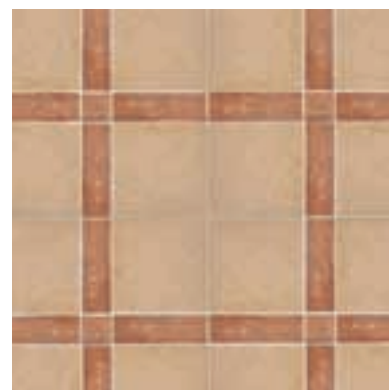

cm 33x33 = 75,4%
cm 10x33 = 22,8%
cm 10x10 = 1,8%

PEZZI SPECIALI TRIMS ACCESSOIRES FORMSTÜCKE

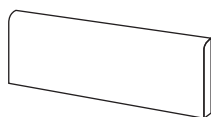

battiscopa bullnose plinthe à bord arrondi Stehsockel

cm 8x33 - 3 $\frac{1}{4}$ "x13"

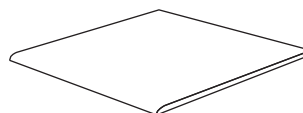

gradino step tread nez de marche Stufenplatte

cm 33x33 - 13"x13"



Medici, Estensi cm 41x41, Fascia Marmo Trani Chiaro, Tozzetto Marmo Biancone



Medici

G4

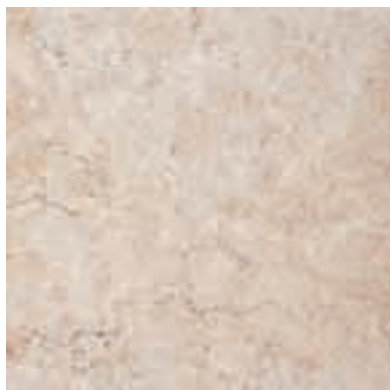

Visconti

G4

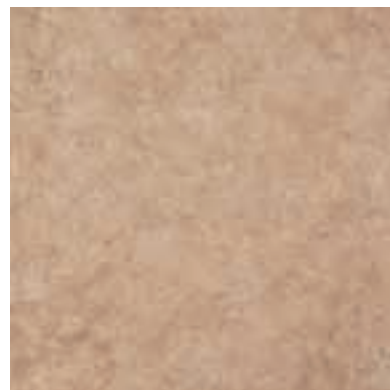

Savoia

G4



Estensi

G4

TABELLA RIASSUNTIVA FORMATI-SUPERFICI-SPESSORI
TABLE SUMMARISING SIZES-SURFACES-THICKNESSES
TABLEAU RECAPITULATIF DES FORMATS-SURFACES-EPAISSEURS
ZUSAMMENFASSENDE TABELLE FORMATE-OBERFLÄCHEN-STÄRKEN

Formati Sizes **Formats** **Formate**

cm 33x33 - 13"x13"

cm 41x41 - 16^{3/8}"x16^{3/8}"

Tutti colori All colours **Touts les couleurs** **Allen farben**



Spessori Thicknesses **Epaisseurs** **Stärken**

mm 8,3

mm 8,8

PEZZI SPECIALI TRIMS ACCESSOIRES FORMSTÜCKE

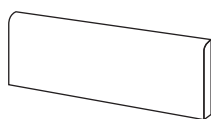

battiscopa bullnose **plinthe à bord arrondi** **Stehsockel**

cm 8x33 - 3^{1/4}"x13"
 cm 8x41 - 3^{1/4}"x16^{3/8}"

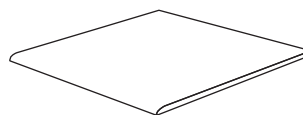

gradino step **tread nez de marche** **Stufenplatte**

cm 33x33 - 13"x13"

DECORI DECORS DECORS DEKORE



*Fascia Marmo Trani Chiaro
cm 4x41 - 1 $\frac{1}{2}$ "x16 $\frac{3}{8}$ "



*Fascia Marmo Trani Chiaro
cm 4x33 - 1 $\frac{1}{2}$ "x13"



**Tozzetto Marmo Trani Chiaro
cm 4x4 - 1 $\frac{1}{2}$ "x1 $\frac{1}{2}$ "

*Marmo naturale *Natural marble* *Marbre naturel* *Natur marmor*
disponibile nei colori *available in the colours* *disponible dans les couleurs* *verfügbar in den folgenden Farben:*
Trani Chiaro, Biancone

**Marmo naturale *Natural marble* *Marbre naturel* *Natur marmor*
disponibile nei colori *available in the colours* *disponible dans les couleurs* *verfügbar in den folgenden Farben:*
Biancone, Trani Chiaro, Rosso Verona, Verde Alpi



Visconti cm 33x33, Fascia Marmo Biancone, Tozzetto Marmo Verde Alpi



Coccio Arancio
cm 15x30 - 6"x12"

G4



Coccio Giallo
cm 15x30 - 6"x12"

G4



Coccio Rosso
cm 15x30 - 6"x12"

G4



Coccio Arancio G4
cm 15x30 - 6"x12"

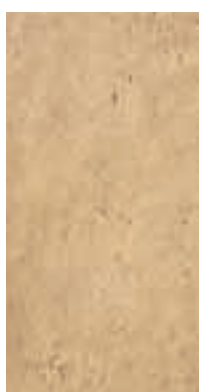

Coccio Giallo G4
cm 15x30 - 6"x12"



Coccio Rosso G4
cm 15x30 - 6"x12"

TABELLA RIASSUNTIVA FORMATI-SUPERFICI-SPESSORI
TABLE SUMMARISING SIZES-SURFACES-THICKNESSES
TABLEAU RECAPITULATIF DES FORMATS-SURFACES-EPAISSEURS
ZUSAMMENFASSENDE TABELLE FORMATE-OBERFLÄCHEN-STÄRKEN

Formati Sizes **Formats** **Formate**

cm 15x30 - 6"x12"

cm 30x30 - 12"x12"

Tutti colori All colours **Touts les couleurs** **Allen farben**



Spessori Thicknesses **Epaisseurs** **Stärken**

mm 8,3

mm 8,3

PEZZI SPECIALI TRIMS ACCESSOIRES FORMSTÜCKE

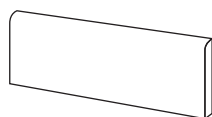

battiscopa **bullnose** **plinthe à bord arrondi** **Stehsockel**

cm 9x30 - 3 1/2"x12"

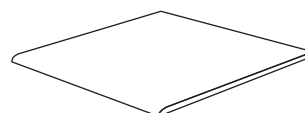

gradino **step** **tread** **nez de marche** **Stufenplatte**

cm 30x30 - 12"x12"



Cotto Ramato cm 30x30, Fascia Decoro, Tozzetto Cotto



Cotto Ramato

G4

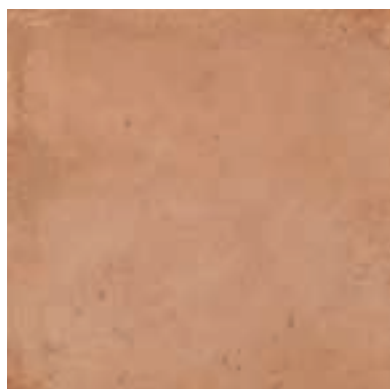

Cotto Rosato

G4



Cotto Paglierino

G4

DECORI DECORS DECORS DEKORE



*Inserto decoro Cotto Ramato
cm 30x30 - 12"x12"



Le piastrelle della serie Cotto Cerato possono essere fornite con uno o più angoli tagliati, per creare varie composizioni insieme al tozzetto. The tiles in the Cotto Cerato series can be supplied with one or more corners cut so that different laying patterns can be created with the inserts. Les carreaux de la série Cotto Cerato peuvent être fournis avec un ou plusieurs angles découpés, de façon à pouvoir réaliser différentes compositions avec le cabochon. Die Fliesen der Serie Cotto Cerato können mit einer oder mehreren abgeschnittenen Ecken geliefert werden, sodass mit den Einlegern verschiedene Gestaltungen möglich sind.



**Fascia decoro Cotto
cm 9x30 - 3 1/2"x12"



**▲Tozzetto Cotto
cm 9x9 - 3 1/2"x3 1/2"

*Disponibile in tutti i colori della serie. Available in all colours of the series. Disponible dans tous les couleurs de la série. Verfügbar in allen Farben.

**Decorati abbinabili a tutti i colori. Decors suitable for every colour. Décors qui peuvent être posés avec toutes les couleurs. Dekore kombinierbar zu allen Farben.

▲Venduti assortiti in scatole da pz 18. Each box contains 18 assorted pieces. Emballages de 18 pièces assorties. Diese Artikel werden im Sortiment zu 18 Stück verkauft

TABELLA RIASSUNTIVA FORMATI-SUPERFICI-SPESSORI
TABLE SUMMARISING SIZES-SURFACES-THICKNESSES
TABLEAU RECAPITULATIF DES FORMATS-SURFACES-EPAISSEURS
ZUSAMMENFASSENDE TABELLE FORMATE-OBERFLÄCHEN-STÄRKEN

Formati Sizes **Formats** Formate

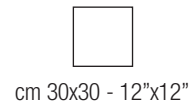

cm 30x30 - 12"x12"

Tutti colori All colours **Touts les couleurs** Allen farben



Spessori Thicknesses **Epaisseurs** Stärken

mm 9

PEZZI SPECIALI TRIMS ACCESSOIRES FORMSTÜCKE

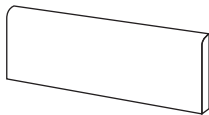

battiscopa bullnose **plinthe à bord arrondi** Stehsockel

cm 9x30 - 3 1/2"x12"

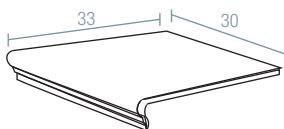

gradone

Pezzo unico **Single piece** Pièce unique Einzelstück
cm 30x33 - 12"x13"

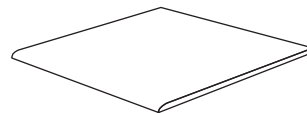

gradino step **tread nez de marche** Stufenplatte

cm 30x30 - 12"x12"

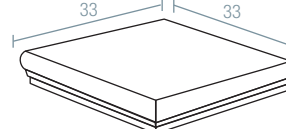

gradone angolare

Pezzo unico **Single piece** Pièce unique Einzelstück
cm 33x33 13"x13"



Europa Grigio, Europa Grigio Friction cm 30x30

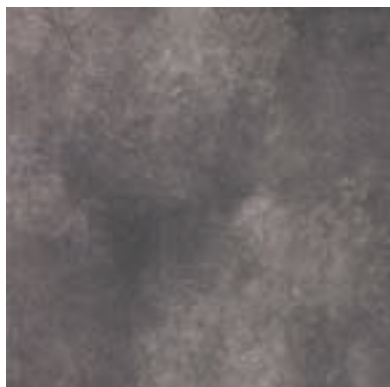

Europa Nero



Europa Grigio



Europa Bianco



Europa Verde



Europa Pesca



Europa Rosa

TABELLA RIASSUNTIVA FORMATI-SUPERFICI-SPESSORI
TABLE SUMMARISING SIZES-SURFACES-THICKNESSES
TABLEAU RECAPITULATIF DES FORMATS-SURFACES-EPAISSEURS
ZUSAMMENFASSENDER TABELLE FORMATE-OBERFLÄCHEN-STÄRKEN

Formati Sizes **Formats** **Formate**

cm 30x30 - 12"x12"

cm 41x41 - 16^{3/8}"x16^{3/8}"

Tutti colori All colours **Touts les couleurs** **Allen farben**



Spessori Thicknesses **Epaisseurs** **Stärken**

mm 8,3

mm 8,8

● Naturale **Matt** Naturelle **Natur** ● Friction **R11 A**

PEZZI SPECIALI TRIMS ACCESSOIRES FORMSTÜCKE

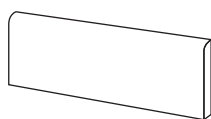

battiscopa bullnose **plinthe à bord arrondi** **Stehsockel**

cm 8x30 - 3^{1/4}"x12"
 cm 8x41 - 3^{1/4}"x16^{3/8}"

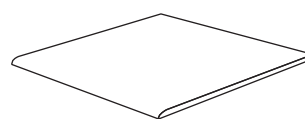

gradino step **tread nez de marche** **Stufenplatte**

cm 30x30 - 12"x12"



Tampa cm 45x45



Orlando G4



Daytona G4

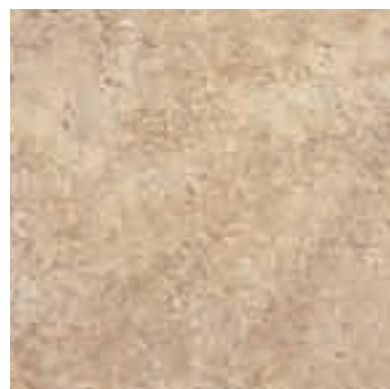

Tampa G4



Cocoa G4



Flamingo G4

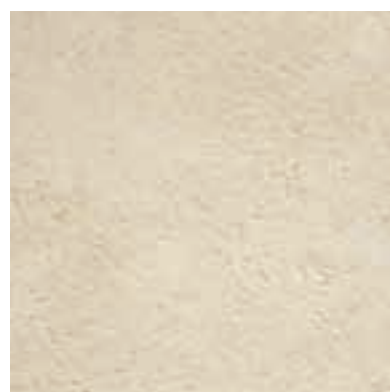

Miami G4

TABELLA RIASSUNTIVA FORMATI-SUPERFICI-SPESSORI
TABLE SUMMARISING SIZES-SURFACES-THICKNESSES
TABLEAU RECAPITULATIF DES FORMATS-SURFACES-EPAISSEURS
ZUSAMMENFASSENDE TABELLE FORMATE-OBERFLÄCHEN-STÄRKEN

Formati Sizes **Formats** **Formate**

cm 10x10 - 4"x4"

cm 45x45 - 18"x18"

Tutti colori All colours **Touts les couleurs** **Allen farben**



Spessori Thicknesses **Epaisseurs** **Stärken**

mm 9

mm 9

PEZZI SPECIALI TRIMS ACCESSOIRES FORMSTÜCKE

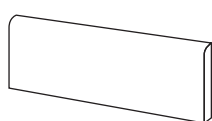

battiscopa bullnose
plinthe à bord arrondi Stehsockel

cm 9x45
3 1/2"x18"

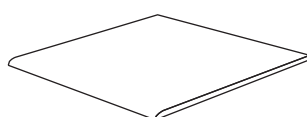

gradino step tread
nez de marche Stufenplatte

cm 45x45
18"x18"



bordo e bordo angolo Bullnose edge
Rebord + Angle Terminale mit abgerundeter kante

cm 10x10
4"x4"

DECORI DECORS DECORS DEKORE

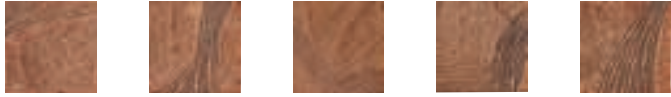

Tozzetto decoro Decorated insert Cabochon décor Dekoreinleger
cm 11x11 - 4 $\frac{3}{8}$ "x4 $\frac{3}{8}$ "

Disponibile su tutti i colori, assortiti nei vari disegni.
Available in all colors, assorted designs.
Disponibile dans toutes les couleurs, assortis dans les différentes finitions.
Für allen Farben, gemischte Dekore.



Tessera
cm 7x7 - 2 $\frac{3}{4}$ "x2 $\frac{3}{4}$ "



*Mosaico Mix
Orlando/Cocoa/Flamingo/Tampa
cm 45x45 - 18"x18"
(su rete on net sur trame auf Netz)

**Mosaico Flamingo
cm 45x45 - 18"x18"
(su rete on net sur trame auf Netz)



Mosaico Mix Tampa/Orlando, Mosaico Mix Orlando/Cocoa/Flamingo/Tampa



***Capitello Palatino A
cm 5x7,3 - 2"x3"



***Spigolo Capitello
Palatino A



**Matita Palatino A
cm 3x7,3 - 1 $\frac{1}{8}$ "x3"



***Spigolo Matita
Palatino A

*disponibile nei colori available in the colours disponible dans les couleurs verfügbar in den folgenden Farben:

Orlando/Cocoa/Flamingo/Tampa, Tampa/Orlando

disponibile nei colori available in the colours disponible dans les couleurs verfügbar in den folgenden Farben: **Flamingo, Miami

***Marmo naturale Natural marble Marbre naturel Natur Marmor

Disponibile nelle versioni Available in the colours Disponible dans les couleurs Verfügbar in den folgenden Farben:

A (Travertino Noce) - B (Rosso Verona) - C (Rosa Portogallo)



Daytona cm 45x45



Tampa/Flamingo cm 10x10, 45x45



Lino Beige cm 33x33

DECORI DECORS DECORS DEKORE



*Fascia Lino
cm 6,5x33 - 2 $\frac{1}{2}$ "x13"

*Disponibile in tutti i colori della serie Available in all colours of the series Disponible dans tous les couleurs de la série Verfügbar in allen Farben

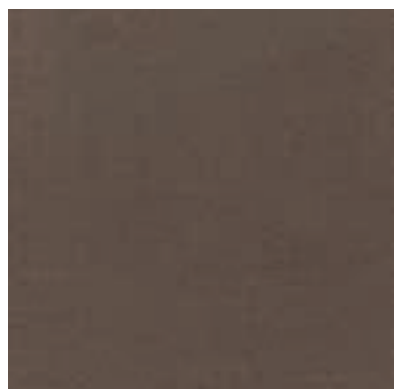

Caffè G3



Beige G4



Bianco G4

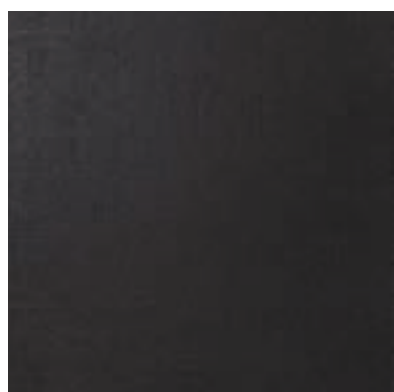





Nero G3



Azzurro G4

TABELLA RIASSUNTIVA FORMATI-SUPERFICI-SPESSORI
TABLE SUMMARISING SIZES-SURFACES-THICKNESSES
TABLEAU RECAPITULATIF DES FORMATS-SURFACES-EPAISSEURS
ZUSAMMENFASSENDE TABELLE FORMATE-OBERFLÄCHEN-STÄRKEN

Formati Sizes Formats Formate		
	cm 33x33 - 13"x13"	cm 41x41 - 16 ³ / ₈ "x16 ³ / ₈ "
Tutti colori All colours Touts les couleurs Allen farben*		
Spessori Thicknesses Epaisseurs Stärken	mm 8,3	mm 8,8

PEZZI SPECIALI TRIMS ACCESSOIRES FORMSTÜCKE

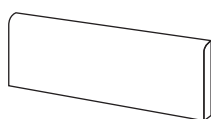

battiscopa bullnose plinthe à bord arrondi Stehsockel

cm 8x33 - 8x41
 3 ¹/₄"x13" - 3 ¹/₄"x16 ³/₈"

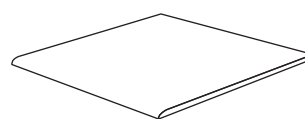

gradino step tread nez de marche Stufenplatte

cm 33x33
 13"x13"



Lounge Grigio cm 41x41



Marrone G4



Rosa G4



Beige G4

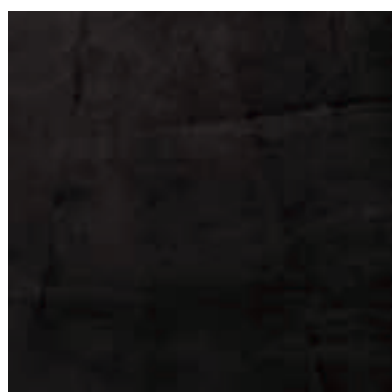

Nero G3



Grigio G4



Bianco G4

TABELLA RIASSUNTIVA FORMATI-SUPERFICI-SPESSORI
TABLE SUMMARISING SIZES-SURFACES-THICKNESSES
TABLEAU RECAPITULATIF DES FORMATS-SURFACES-EPAISSEURS
ZUSAMMENFASSENDE TABELLE FORMATE-OBERFLÄCHEN-STÄRKEN

Formati Sizes **Formats** **Formate**

 cm 33x33 - 13"x13"

 cm 41x41 - 16 ³/₈"x16 ³/₈"

Tutti colori All colours **Touts les couleurs** **Allen farben**



Spessori Thicknesses **Epaisseurs** **Stärken**

mm 8,3

mm 8,8

PEZZI SPECIALI TRIMS ACCESSOIRES FORMSTÜCKE

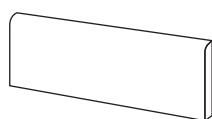

battiscopa bullnose plinthe à bord arrondi Stehsockel

cm 8x33 - 8x41
 3 ¹/₄"x13" - 3 ¹/₄"x16 ³/₈"

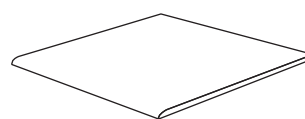

gradino step tread nez de marche Stufenplatte

cm 33x33
 13"x13"



Trani Chiaro/Rosso Verona cm 15x15,15x30, 30x30



Adriano

G4



Augusto

G4

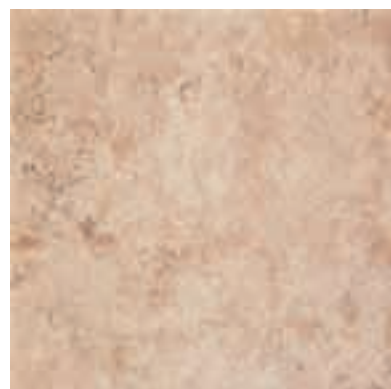

Caligola

G4

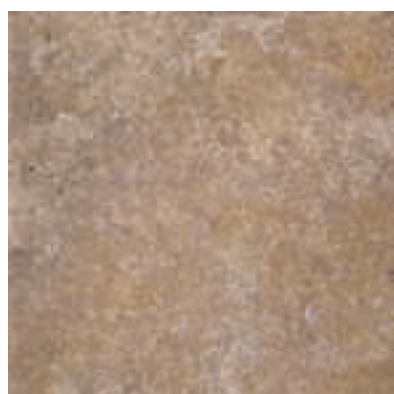

Claudio

G4



Domiziano

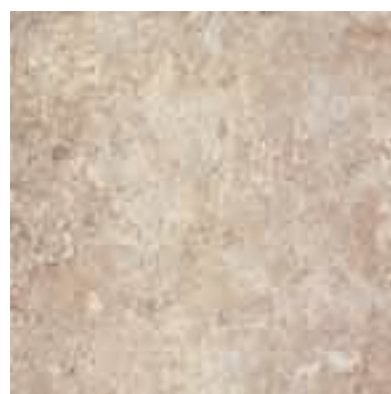

G4



Tiberio

G4

TABELLA RIASSUNTIVA FORMATI-SUPERFICI-SPESSORI
TABLE SUMMARISING SIZES-SURFACES-THICKNESSES
TABLEAU RECAPITULATIF DES FORMATS-SURFACES-EPAISSEURS
ZUSAMMENFASSENDE TABELLE FORMATE-OBERFLÄCHEN-STÄRKEN

Formati Sizes Formats Formate	 cm 30x30 12"x12"	 cm 30x60 12"x24"	 cm 45x45 18"x18"
Tutti colori All colours Touts les couleurs Allen farben	●	●	●
Spessori Thicknesses Epaisseurs Stärken	mm 9	mm 9	mm 9

Su richiesta, le piastrelle della Serie Palatino, possono essere fornite squadrate e rettificate in modo da consentire la posa senza fuga. Tale richiesta deve essere espressamente indicata nell'ordine. On request, Palatino Series tiles can be supplied squared and ground so that they can be fixed without gaps. This must be explicitly indicated in the order. Sur demande, les carreaux de la série Palatino peuvent être fournis équarris et rectifiés de manière à permettre la pose sans joint. Cette demande doit être indiquée expressément dans la commande. Auf Wunsch können die Fliesen der Serie Palatino zugeschnitten und geschliffen geliefert werden, damit die Verlegung ohne Fuge möglich ist. Dieser Wunsch ist ausdrücklich auf dem Auftrag anzugeben.

DECORI RIVESTIMENTO DECORS FOR WALL-CLADDING
 DECORS POUR REVETEMENT MUR DEKORE FÜR WANDFLIESEN



Tessera
 cm 7,3x7,3 - 3"x3"

Mosaico
 Claudio-Adriano-Domiziano
 cm 30x30 - 12"x12"
 (su rete on net sur trame auf Netz)



Tessera
 cm 7,3x7,3 - 3"x3"

Mosaico
 Domiziano - Caligola
 cm 30x30 - 12"x12"
 (su rete on net sur trame auf Netz)



Riquadro cucina
 cm 22,5x45,5 - 9"x18"



Inserto marmo frutta
 cm 7,3x7,3 - 3"x3"



Inserto cucina
 cm 7,3x7,3 - 3"x3"



Fascia Palatino (Claudio)
 cm 10x30 - 4"x12"



Fascia Palatino (Claudio)
 cm 5x30 - 2"x12"



*Matita Adriano
 cm 3x30 - 1 1/8"x12"



*Spigolo
 Matita
 Adriano



*London Adriano
 cm 8x30 - 3 1/4"x12"



*Spigolo
 London
 Adriano



*Tavella decoro Adriano
 cm 10x30 - 4"x12"



**Capitello
 Palatino A
 cm 5x7,3 - 2"x3"



**Spigolo
 Capitello
 Palatino A



**Matita
 Palatino A
 cm 3x7,3 - 1 1/8"x3"



**Spigolo
 Matita
 Palatino A

*Disponibile in tutti i colori della serie Available in all colours of the series Disponible dans tous les couleurs de la série Verfügbar in allen Farben:

Marmo naturale Natural marble Marbre naturel Natur marmor **A (Travertino Noce), B (Rosso Verona), C (Rosa Portogallo)



Domiziano cm 30x30, Mosaico Domiziano/Caligola



Claudio cm 30x60, Fascia Palatino



Tiberio cm 30x60, Tavella e London Tiberio

DECORI PAVIMENTO DECORS FOR FLOORS
DECORS POUR REVETEMENT SOL DEKORE FÜR BODENFLIESEN



*Inserto Augusto Quadro
cm 30x30 - 12"x12"



*Inserto Augusto Tondo
cm 30x30 - 12"x12"



*Fascia Riposo Augusto
cm 15x45 - 6"x18"



*Fascia Decoro Augusto
cm 15x45 - 6"x18"



*Angolo Augusto
cm 15x15 - 6"x6"

*Disponibile nelle versioni Available in the colours Disponible dans les couleurs Verfügbar in den folgenden Farben:
Augusto (Augusto/Tiberio/Caligola), Claudio (Claudio/Domiziano/Adriano)

PEZZI SPECIALI TRIMS ACCESSOIRES FORMSTÜCKE

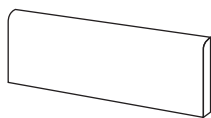

battiscopa bullnose plinthe à bord arrondi Stehsockel

cm 9x30 - 9x45
3 1/2"x12" - 3 1/2"x18"

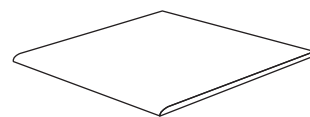

gradino step tread nez de marche Stufenplatte

cm 30x30
12"x12"



Augusto cm 30x60



Caligola, Augusto cm 45x45, Fascia decoro Augusto





Nettuno G4
cm 30x30 - 12"x12"

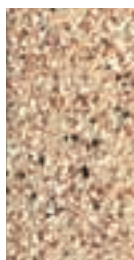

Nettuno G4
cm 10x20 - 4"x8"

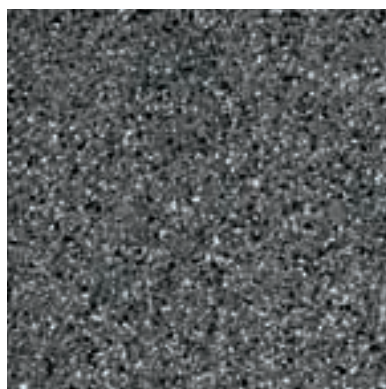

Mercurio G4
cm 30x30 - 12"x12"

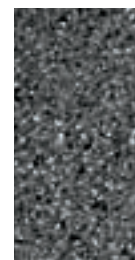

Mercurio G4
cm 10x20 - 4"x8"



Saturno G4
cm 30x30 - 12"x12"



Saturno G4
cm 10x20 - 4"x8"



Giove G4
cm 30x30 - 12"x12"

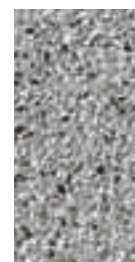

Giove G4
cm 10x20 - 4"x8"

TABELLA RIASSUNTIVA FORMATI-SUPERFICI-SPESSORI
TABLE SUMMARISING SIZES-SURFACES-THICKNESSES
TABLEAU RECAPITULATIF DES FORMATS-SURFACES-EPAISSEURS
ZUSAMMENFASSENDE TABELLE FORMATE-OBERFLÄCHEN-STÄRKEN

Formati Sizes Formats Formate	cm 10x20 - 4"x8"	cm 30x30 - 12"x12"
Superfici Surfaces Surfaces Oberflächen	●	●
Spessori Thicknesses Epaisseurs Stärken	mm 8	mm 8,3

R10 A

PEZZI SPECIALI TRIMS ACCESSOIRES FORMSTÜCKE

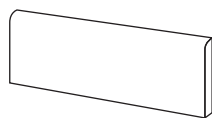

battiscopa bullnose plinthe à bord arrondi Stehsockel

cm 8x30 - 4"x12"

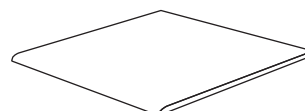

gradino step tread nez de marche Stufenplatte

cm 30x30 - 12"x12"



Rapolano Beige cm 45x45, Rapolano Mattoncini



Trani Chiaro

G4



Perlino Rosato

G4



Rosso Verona

G4



Chiampo Perlato

G4

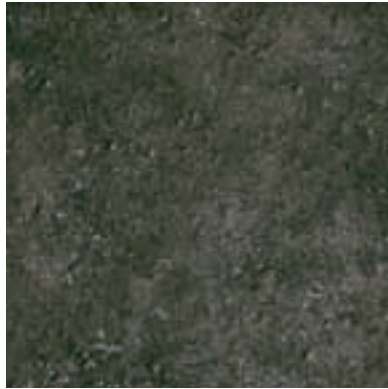

Verde Alpi



G4



Grigio Carnico

G4

TABELLA RIASSUNTIVA FORMATI-SUPERFICI-SPESSORI
TABLE SUMMARISING SIZES-SURFACES-THICKNESSES
TABLEAU RECAPITULATIF DES FORMATS-SURFACES-EPAISSEURS
ZUSAMMENFASSENDE TABELLE FORMATE-OBERFLÄCHEN-STÄRKEN

Formati Sizes Formats Formate	 cm 15x15 6"x6"	 cm 15x30 6"x12"	 cm 30x30 12"x12"
Tutti colori All colours Touts les couleurs Allen farben	●	●	●
Spessori Thicknesses Epaisseurs Stärken	mm 8,3	mm 8,3	mm 8,3

DECORI DECORS DECORS DEKORE



*Trani Pavè
cm 30x30 - 12"x12"

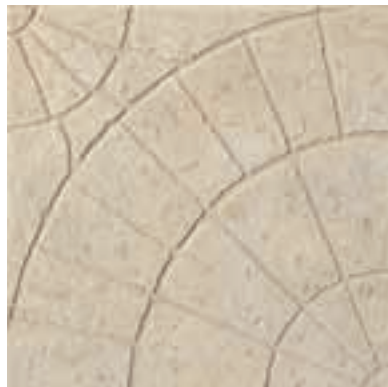

**Trani Pavone
cm 30x30 - 12"x12"



***Pavone Bicolore
cm 30x30 - 12"x12"



*Pavè disponibile nei colori available in the colours disponible dans les couleurs verfügbar in den folgenden Farben: **Trani, Perlino**

Pavone disponibile nei colori available in the colours disponible dans les couleurs verfügbar in den folgenden Farben: **Trani, Perlino, Chiampo

***Pavone Bicolore disponibile nei colori available in the colours disponible dans les couleurs verfügbar in den folgenden Farben:

Trani/Verde, Chiampo/Rosso



Inserto Cestino Frutta
cm 30x45 - 12"x18"



Inserto Frutta Arancio
cm 15x15 - 6"x6"



Inserto Frutta Limone
cm 15x15 - 6"x6"

Decorì in marmo naturale. Decorations in natural marble. Décors en marbre naturel. Dekore aus natürlichen marmor.

Disponibilità standard per fondo Trani. Standard availability of the "Trani" basic tile. Disponibilité standard du fond "Trani".

Die Grundfliese "Trani" ist standardmäßig lieferbar.



Fascia Riposo
cm 15x30 - 6"x12"
**(Rosso Verona/Trani Chiaro/
Perlino Rosato)**



Fascia Decoro
cm 15x30 - 6"x12"
**(Rosso Verona/Trani Chiaro/
Perlino Rosato)**



Angolo
cm 15x15 - 6"x6"
**(Rosso Verona/Trani Chiaro/
Perlino Rosato)**



Rosone
cm 90x90 - 36"x36"

PEZZI SPECIALI TRIMS ACCESSOIRES FORMSTÜCKE

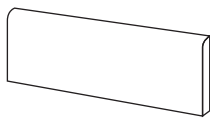

battiscopa bullnose
plinthe à bord arrondi Stehsockel

cm 9x30
3 1/2"x12"



***frontale**

cm 15x4,5x3
6"x1 3/4"x1 1/8"

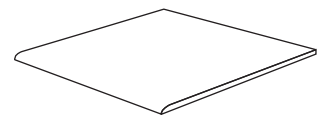

gradino step tread
nez de marche Stufenplatte

cm 30x30
12"x12"

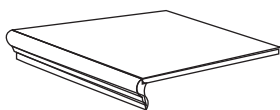

***gradone**

cm 30x30 - 12"x12"

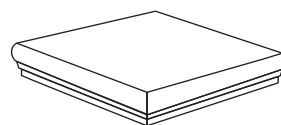

***gradone angolare**

cm 30x30 - 12"x12"

* Torello in marmo naturale. Bullnose in natural marble. Rebord en marbre naturel. Front aus geklebtem natur marmor.



Arianna cm 16,5x33, 33x33, Decoro Arianna

DECORI DECORS DECORS DEKORE



*Quadrota Decoro
cm 16,5x16,5 - 6 $\frac{1}{2}$ "x6 $\frac{1}{2}$ "



*Tavella Decoro
cm 16,5x33 - 6 $\frac{1}{2}$ "x13"



*Angolo Decoro
cm 16,5x16,5 - 6 $\frac{1}{2}$ "x6 $\frac{1}{2}$ "

*Disponibile in tutti i colori della serie. Available in all colours of the series. Disponible dans tous les couleurs de la série. Verfügbar in allen Farben.



Kronos

G4



Icaro

G4



Teseo







G4



Arianna

G4

TABELLA RIASSUNTIVA FORMATI-SUPERFICI-SPESSORI
TABLE SUMMARISING SIZES-SURFACES-THICKNESSES
TABLEAU RECAPITULATIF DES FORMATS-SURFACES-EPAISSEURS
ZUSAMMENFASSENDE TABELLE FORMATE-OBERFLÄCHEN-STÄRKEN

Formati Sizes Formats Formate			
	cm 16,5x16,5 - 6 1/2"x13"	cm 16,5x33 - 6 1/2"x13"	cm 33x33 - 13"x13"
Tutti colori All colours Tous les couleurs Allen farben			
Spessori Thicknesses Epaisseurs Stärken	mm 8,3	mm 8,3	mm 8,3

PEZZI SPECIALI TRIMS ACCESSOIRES FORMSTÜCKE

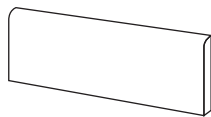

battiscopa bullnose plinthe à bord arrondi Stehsockel

cm 8x33 - 3 1/4"x13"

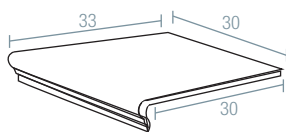

gradone

Pezzo unico Single piece Pièce unique Einzelstück
 cm 30x33 - 12"x13"

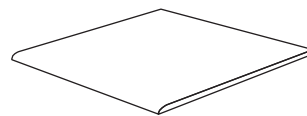

gradino step tread nez de marche Stufenplatte

cm 33x33 - 13"x13"

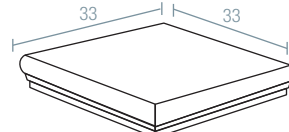

gradone angolare

Pezzo unico Single piece Pièce unique Einzelstück
 cm 33x33 - 13"x13"



Spring cm 15x30



Summer
cm 30x30 - 12"x12"

G4



Summer
cm 15x30 - 6"x12"

G4



Winter
cm 30x30 - 12"x12"

G4



Winter
cm 15x30 - 6"x12"

G4



Autumn
cm 30x30 - 12"x12"

G4



Autumn
cm 15x30 - 6"x12"

G4



Spring
cm 30x30 - 12"x12"

G4



Spring
cm 15x30 - 6"x12"

G4

DECORI DECORS DECORS DEKORE





*Fascia Old Season
cm 7x30 - 2³/₄"x12"



*Tozzetto Old Season
cm 7x7 - 2³/₄"x2³/₄"

*Decori abbinabili a tutti i colori. Decors suitable for every colour. Décors qui peuvent être posé avec toutes les couleurs. Dekore kombinierbar zu allen Farben.

TABELLA RIASSUNTIVA FORMATI-SUPERFICI-SPESSORI
TABLE SUMMARISING SIZES-SURFACES-THICKNESSES
TABLEAU RECAPITULATIF DES FORMATS-SURFACES-EPAISSEURS
ZUSAMMENFASSENDE TABELLE FORMATE-OBERFLÄCHEN-STÄRKEN

		
Formati Sizes Formats Formate	cm 15x30 - 6"x12"	cm 30x30 - 12"x12"
Tutti colori All colours Touts les couleurs Allen Farben	●	●
Spessori Thicknesses Epaisseurs Stärken	mm 8,3	mm 8,3

PEZZI SPECIALI TRIMS ACCESSOIRES FORMSTÜCKE

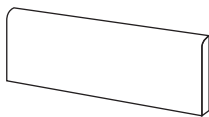

battiscopa bullnose **plinthe à bord arrondi** **Stehsockel**

cm 9x30 - 3¹/₂"x12"

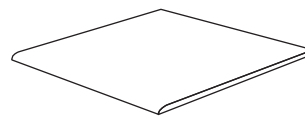

gradino step **tread nez de marche** **Stufenplatte**

cm 30x30 - 12"x12"

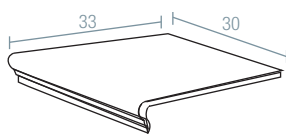

gradone

Pezzo unico **Single piece** **Pièce unique** **Einzelstück**
cm 30x33 - 12"x13"

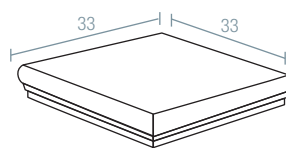

gradone angolare

Pezzo unico **Single piece** **Pièce unique** **Einzelstück**
cm 33x33 - 13"x13"



Claudio/Adriano cm 30x30, Insetto Claudio Tondo, Insetto Claudio Quadrato



Rapolano White G4



Rapolano Beige G4

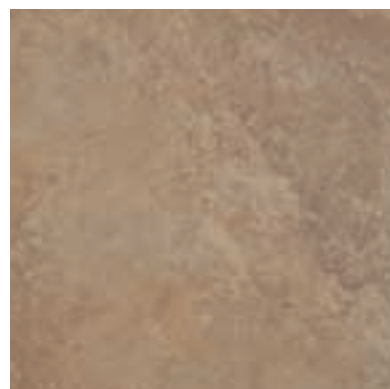

Rapolano Walnut G4



Rapolano Brown G4

TABELLA RIASSUNTIVA FORMATI-SUPERFICI-SPESSORI
TABLE SUMMARISING SIZES-SURFACES-THICKNESSES
TABLEAU RECAPITULATIF DES FORMATS-SURFACES-EPAISSEURS
ZUSAMMENFASSENDER TABELLE FORMATE-OBERFLÄCHEN-STÄRKEN

Formati Sizes **Formats** **Formate**

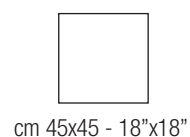

cm 45x45 - 18"x18"

Tutti colori All colours **Touts les couleurs** **Allen farben**



Spessori Thicknesses **Epaisseurs** **Stärken**

mm 9,5

PEZZI SPECIALI TRIMS ACCESSOIRES FORMSTÜCKE

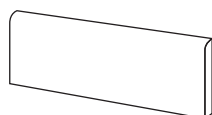

battiscopa bullnose **plinthe à bord arrondi** **Stehsockel**

cm 9x45 - 3 1/2"x18"

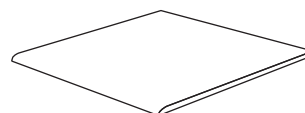

gradino step **tread nez de marche** **Stufenplatte**

cm 45x45 - 18"x18"



DECORI DECORS DECORS DEKORE



Tessera
cm 7x7 - 2³/₄"x2³/₄"

Mosaico Rapolano A
White, Beige
cm 45x45 - 18"x18"
(su rete on net sur trame auf Netz)



Tessera
cm 7x7 - 2³/₄"x2³/₄"

Mosaico Rapolano B
Beige, Walnut, Brown
cm 45x45 - 18"x18"
(su rete on net sur trame auf Netz)

DECORI DECORS DECORS DEKORE



Rapolano Rombi
(Beige, Walnut, Brown)
 cm 33x33 - 13"x13"
 (su rete on net sur trame auf Netz)

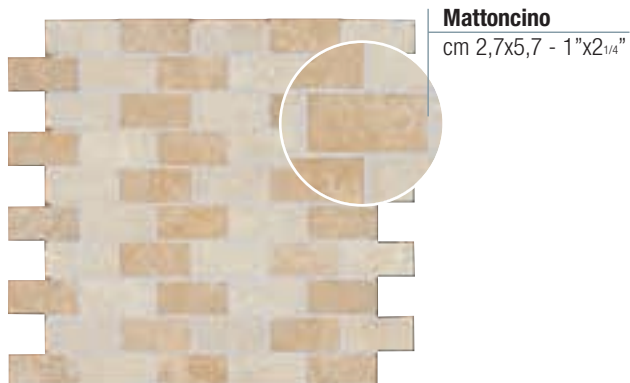

Rapolano Mattoncini
(White, Beige)
 cm 33x33 - 13"x13"
 (su rete on net sur trame auf Netz)



*Capitello
 Palatino A
 cm 5x7,3 - 2"x3"



*Spigolo
 Capitello
 Palatino A



*Matita
 Palatino A
 cm 3x7,3 - 1 1/8"x3"



*Spigolo
 Matita
 Palatino A

* Marmo naturale Natural marble Marbre naturel Natur marmor **Travertino Noce**





Alpi cm 30x30



Himalaya
cm 30x30 - 12"x12"

G4



Himalaya
cm 15x30 - 6"x12"

G4



Atlante
cm 30x30 - 12"x12"

G4

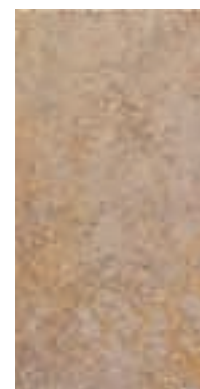

Atlante
cm 15x30 - 6"x12"

G4



Ande
cm 30x30 - 12"x12"

G4

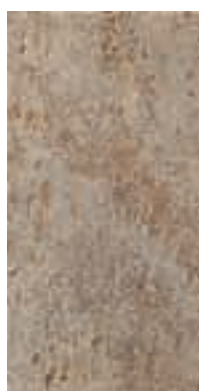

Ande
cm 15x30 - 6"x12"

G4



Alpi
cm 30x30 - 12"x12"

G4



Alpi
cm 15x30 - 6"x12"

G4

TABELLA RIASSUNTIVA FORMATI-SUPERFICI-SPESSORI
TABLE SUMMARISING SIZES-SURFACES-THICKNESSES
TABLEAU RECAPITULATIF DES FORMATS-SURFACES-EPAISSEURS
ZUSAMMENFASSENDER TABELLE FORMATE-OBERFLÄCHEN-STÄRKEN

Formati Sizes Formats Formate	cm 15x30 - 6"x12"	cm 30x30 - 12"x12"
Superfici Surfaces Surfaces Oberflächen	●	●
Spessori Thicknesses Epaisseurs Stärken	mm 8,3	mm 8,3

R10 A+B

PEZZI SPECIALI TRIMS ACCESSOIRES FORMSTÜCKE

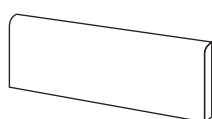

battiscopa bullnose
plinthe à bord arrondi **Stehsckel**

cm 8x30 - 3¹/₄"x12"

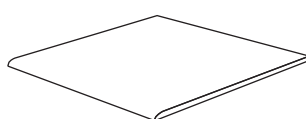

gradino step tread
nez de marche **Stufenplatte**

cm 30x30 - 12"x12"

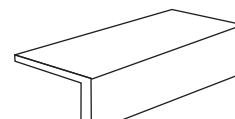

terminale pezzo unico single piece
pièce unique **Einzelstück**

Pezzo unico **Single piece** Pièce unique **Einzelstück**
cm 15x30x3,5 - 6"x12"x1³/₈"

CARATTERISTICHE TECNICHE TECHNICAL FEATURES CARACTERISTIQUES TECHNIQUES TECHNISCHE EIGENSCHAFTEN

46

GRESPLUS



	norma standards norme Norm	risultato prova* test results* resultats des essais* Ergebnisse*
 <p>classificazione prodotto product classification classement Klassifizierung</p>	UNI EN 14411-G ISO 13006	gruppo B1a completamente greificato GL group B1a fully vitrified GL group B1a grès cérame fin GL Gruppe B1a Feinsteinzeug GL
 <p>caratteristiche dimensionali e d'aspetto dimensional and surface quality caractéristiques de la surface Oberflächenqualität</p>	UNI EN ISO 10545-2	tolleranze minime nella 1 ^a scelta very low tolerance des tolérances minimales en 1er choix Entspricht Normen
 <p>assorbimento di acqua water absorption absorption d'eau Wasseraufnahme</p>	UNI EN ISO 10545-3	≤ 0,1%
 <p>resistenza alla flessione flexural strenght résistance a la flexion Biegezug-Festigkeit</p>	UNI EN ISO 10545-4	N/mm ² 50±60
 <p>resistenza al gelo frost resistance résistance au gel Frostwiderstandsfähigkeit</p>	qualsiasi norma all standards toute norme Alle normen	garantita guaranteed garantie Frostsicher
 <p>resistenza attacco chimico (esclusione acido fluoridrico) resistance to acids and alkalis (with the exception of hydrofluoric acid) résistance à l'attaque chimique (exclusion de l'acide fluorhydrique) Säure und Laugen Beständigkeit (mit Ausnahme von Fluorwasserstoff)</p>	UNI EN ISO 10545-13	nessuna alterazione no damage non attaquées Nicht angegriffen
 <p>resistenza usura e abrasione wear and abrasion resistance résistance à l'usure et abrasion Abriebhärte</p>	UNI EN ISO 10545-7	vedere singole serie see every series voir les séries une par une Siehe einzelne Serie
 <p>dilatazione termica lineare linear thermal expansion coefficient linéaire de dilatation thermique Lineare Wärmeausdehnung</p>	UNI EN ISO 10545-8	6,6 x 10 ⁻⁶
 <p>resistenza alle macchie stain resistance résistance aux taches Fleckenfestigkeit</p>		garantita guaranteed garantie garantiert
 <p>resistenza alla scivolosità (Superficie Naturale) slip resistance (Matt surface) résistance au glissement (Surface naturelle) Trittsicherheit (Natur Oberflächen)</p>	DIN 51130	vedere singole serie see every series voir les séries une par une Siehe einzelne Serie
 <p>resistenza dei colori alla luce light fastness résistance de la couleur à la lumière Unveränderlichkeit der Farben wenn Strahlung zugesetzt wird</p>	DIN 51094	nessuna variazione no change of colours couleurs inchangées Keinerlei Farbänderung

*valore indicativo approx value donnee approximative Ungefähre Werte

norma ASTM
ASTM standards
risultato prova test results
resultats des essais Ergebnisse

ASTM C-373 impervious $\leq 0,5\%$	0,05**
ASTM C-648 breaking strength ≥ 250 lbs	> 510 lbs**
ASTM C-1026 no sample must show alterations to surface	resistant**
ASTM C-650 no sample must show alterations to surface	unaffected**

**test made on Rapolano Brown

Marque NF

U3S P3 E3 C2
 Winter - Arianna - Icaro - Kronos - Teseo -
 Chiampo Perlato - Perlino Rosato - Trani Chiaro

U3 P3 E3 C2
 Spring - Rosso Verona - Verde Alpi

U2S P3 E3 C2
 Autumn - Summer

Classificazione delle piastrelle da pavimento
in base all'ambiente di destinazione
Classification of the floor tiles
according to the final destination
Classification des carreaux
selon l'entroit destine
Klassifizierung der Bodenfliese
nach ihrem Verwendungszweck







G1
Gruppo 1: Traffico leggero (bagni, camere da letto)
Group 1: Light wear (bathrooms, bedrooms)
Groupe 1: Trafic léger
 (salles de bains, chambres à coucher)
Gruppe 1: Leichte Beanspruchung
 (Bade und Schlafzimmer)

G2
Gruppo 2: Traffico-medio
 (appartamenti privati ad esclusione cucine)
Group 2: Medium wear
 (private apartments, kitchens excluded)
Groupe 2: Trafic moyen
 (appartements privatifs sauf cuisines)
Gruppe 2: Beanspruchung
 (Privatwohnungen außer Küchen)

G3
Gruppo 3: Traffico medio-forte
 (appartamenti, case private)
Group 3: Medium hard wear
 (flats and private houses)
Groupe 3: Trafic mi-fort (appartements et maisons)
Gruppe 3: Mittlere Beanspruchung
 (Wohnungen und Privätauser)

G4
Gruppo 4: Traffico forte
 (ristoranti, uffici, edifici pubblici)
Group 4: Hard wear
 (restaurants, offices, public buildings)
Gruppe 4: Trafic fort
 (restaurants, bureaux, édifices publics)
Gruppe 4: Starke Beanspruchung
 (Restaurant, Büros, öffentliche Gebäude)

PESI, MISURE E CONTENUTO DEI COLLI
WEIGHT, SIZE AND CONTENTS OF THE PACKING
POIDS, DIMENSIONS, CONTENU DES COLIS
VERPACKUNGSGRÖßEN/GEWICHTE

							
cm 10x10 - 4"x4"	9	48	0,48	21	60	28,80	605
cm 10x20 - 4"x8"	8	60	1,20	17,5	72	86,40	1512
cm 15x15 - 6"x6"	8,3	44	0,99	18,5	64	63,36	1172
cm 15x30 - 6"x12"	8,3	21	0,945	18	64	60,80	1089
cm 16,5x16,5 - 6 1/2"x6 1/2"	8,3	38	1,034	18,5	64	66,18	1224
cm 16,5x33,3 - 6 1/2"x13"	8,3	19	1,034	18,5	64	66,18	1224
cm 30x30 - 12"x12"	8,3	13	1,17	19	48	56,16	1067
	9 (Cotto Cerato/Palatino)						
cm 33x33 - 13"x13"	8,3	13	1,415	18,5	42	59,43	1099
cm 30x60 - 12"x24"	9	6	1,08	21	48	51,84	1089
cm 41x41 - 16 3/8"x16 3/8"	8,8	8	1,344	20,3	48	64,5	1310
cm 45x45 - 18"x18"	9,5	5	1,012	21	34	34,41	723
	9 (Palatino/Florida)						

Battiscopa B.C. Bullnose Plinthe à bord arrondi Stehsockel

cm 8x30 - 3 1/4"x12"	30	-	-	-	-	-
cm 8x33 - 3 1/4"x13"	30	-	-	-	-	-
cm 8x41 - 3 1/4"x16 3/8"	22	-	-	-	-	-
cm 9x30 - 3 1/2"x12"	30	-	-	-	-	-
cm 9x45 - 3 1/2"x18"	18	-	-	-	-	-

Bordo Bullnose edge Rebord Terminale mit abgerundeter Kante

cm 10x10 - 4"x4"	36	-	-	-	-	-
------------------	----	---	---	---	---	---

Bordo Angolo Bullnose Edge Rebord+Angle Terminale mit abgerundeter Kante

cm 10x10 - 4"x4"	2	-	-	-	-	-
------------------	---	---	---	---	---	---

Gradino Step tread Nez de marche Stufenplatte

cm 30x30 - 12"x12"	13	-	-	-	-	-
cm 33x33 - 13"x13"	13	-	-	-	-	-
cm 45x45 - 18"x18"	5	-	-	-	-	-

gradone

cm 30x30 - 12"x12"	4	-	-	-	-	-
cm 30x33 - 12"x13"	4	-	-	-	-	-

gradone angolare

cm 33x33 - 12"x12"	3	-	-	-	-	-
--------------------	---	---	---	---	---	---

gradone angolare marmorea

cm 30x30 - 12"x12"	3	-	-	-	-	-
--------------------	---	---	---	---	---	---

terminale

cm 15x30x3,5 - 6"x12"x1 3/8"	6	-	-	-	-	-
------------------------------	---	---	---	---	---	---

Casalgrande Padana

via Statale 467 n. 73
42013 Casalgrande (Re) Italy
tel + 39 0522 9901
fax + 39 0522 996121
info@casalgrandepadana.it
www.casalgrandepadana.com



CASALGRANDE
PADANA
Pave your way